

Syringe Catalog



The Measure of Excellence®
for your application



HAMILTON®

Unsurpassed Accuracy and Precision

Hamilton syringes are the finest quality precision fluid measuring devices available. Top quality materials and skilled workmanship ensure that Hamilton syringes consistently deliver the highest possible performance for reliable analyses. For manual uses, our syringes are accurate to within $\pm 1\%$ of the nominal volume with a precision of 1% at 80% of the total volume.

A New Application-Based Catalog

Hamilton offers the most complete selection of syringes on the market for use in various applications including gas chromatography (GC) and high performance liquid chromatography (HPLC), liquid handling and life sciences. The present catalog is a tool to help you select the appropriate syringe for your application. It also provides detailed background and technical information to help you understand the full functionalities and possibilities for your syringes.

Products manufactured by Hamilton Company are intended for scientific research and laboratory use only and are not intended for human *in vivo* use.



Find the Perfect Syringe Online

If you do not find the correct syringe to meet your needs in this catalog, please consult Hamilton's online syringe selection tool at www.hamiltoncompany.com/syringes or contact customer support using the information on the back of the catalog.





HPLC autosampler syringes

See more on [page 20](#)



Neuroscience animal injections

See more on [page 30](#)



Syringe series and family definitions

See more on [page 4](#)

Table of Contents

| | |
|---|-----------|
| Technical Syringe Information..... | 2 |
| Syringe Technical Illustrations | 2 |
| Syringe Series | 4 |
| Syringe Terminations | 4 |
| Needle Point Styles | 4 |
| Gas Chromatography Syringes | 5 |
| Manual Split/Splitless Injection | 6 |
| Manual On-Column Injection | 10 |
| Gas Chromatography Autosampler Syringes..... | 11 |
| Liquid Chromatography Syringes | 16 |
| HPLC Syringes..... | 16 |
| Thin Layer Chromatography | 19 |
| HPLC Autosampler Syringes | 20 |
| Sample Preparation and Liquid Handling | 26 |
| Syringes For the Hamilton Microlab 600..... | 27 |
| Syringes For Laboratory Syringe Pumps | 27 |
| Tubing Assemblies | 27 |
| Life Science Syringes | 29 |
| General Animal Injections | 29 |
| Neuroscience Injections | 30 |
| Genomics and Biochemistry | 34 |
| Product Listing by Features..... | 36 |
| Microliter Syringes | 36 |
| Gastight Syringes | 38 |
| Needles..... | 40 |
| Syringe Care and Use..... | 44 |
| Part Number Index..... | 47 |
| About Hamilton Company | 49 |

For more information on the full portfolio of Hamilton syringes, needles and accessories or to order a product, please visit www.hamiltoncompany.com or refer to the back of this catalog for additional contact details.



Technical Syringe Information

Microliter™ Syringes (700 Series)

Microliter syringes are used with liquid only. They feature a stainless steel plunger which is individually fitted to the glass barrel. The result is a liquid tight seal with nearly frictionless movement. These syringes are ideal for organic samples that are not prone to precipitation, crystallization or bonding with glass.

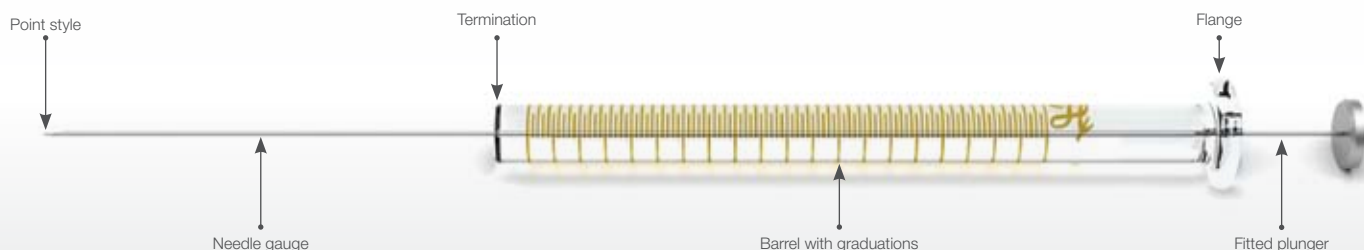

Modified Microliter Syringes (7000 Series)

These syringes are designed to dispense volumes below 5 μL . This requires an extremely small tungsten plunger wire that travels to the tip of the needle. The resulting design has zero dead volume and is accurate below 50 nL.

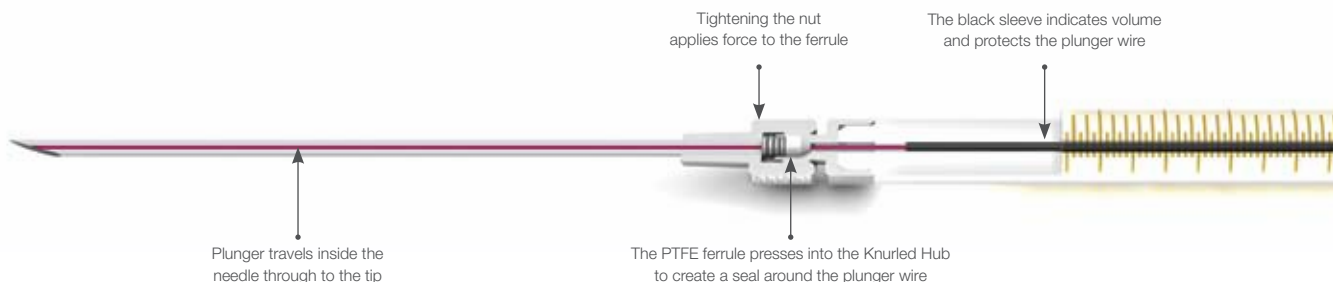

Gastight® Syringes (1700 and 1000 Series)

Gastight syringes are ideal for dispensing both liquids and gases. They have a polymer plunger tip which creates a leak-free seal. Traditionally the tip is made from PTFE but other materials are used for selected applications. The polymer tip essentially wipes the interior of the syringe barrel free of sample. This feature is useful for aqueous and low volatile organic samples because it reduces the chance a deposit will occur and result in cross-contamination or even a damaged plunger.



Reinforced Plunger Syringes (800 and 1800 Series)

Small volume syringes require extremely small plunger wires. For uses that are prone to bending and breaking these small plungers, it is recommended to use a reinforced plunger syringe. These plungers are available in both Microliter and Gastight versions.

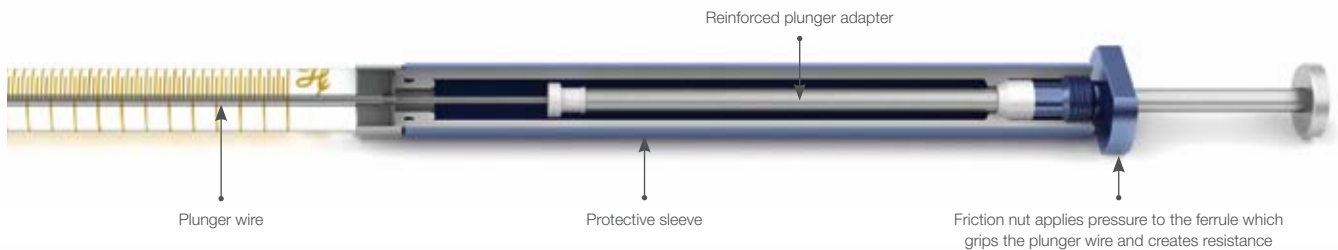







Syringe Series

| Syringe Series | Volume | Syringe Type | Plunger Type |
|----------------|----------------|---------------------|---|
| 7000 | 0.5 µL – 5 µL | Modified Microliter | Tungsten plunger |
| 700 | 5 µL – 500 µL | Microliter | Stainless steel fitted plunger |
| 800 | 5 µL – 250 µL | Microliter | Reinforced stainless steel fitted plunger |
| 1700 | 10 µL – 500 µL | Gastight | Polymer tipped plunger |
| 1800 | 10 µL – 250 µL | Gastight | Reinforced polymer tipped plunger |
| 1000 | 1 mL – 100 mL | Gastight | Polymer tipped plunger |
| Super Syringe | 0.5 L – 2 L | Gastight | Plunger with polymer tip with Buna-N seal |

Syringe Terminations

| Termination | Abbreviation | Remark | Autoclavable |
|-----------------------------|--------------|---|---------------------|
| Cemented Needle | N | For low-volume syringes | No |
| Luer Tip Cemented Needle | LTN | For mid-volume syringes | No |
| Removable Needle | RN | | Yes if disassembled |
| Knurled Hub | KH | For Modified Microliter syringes only | Yes if disassembled |
| Luer Tip | LT | | Yes if disassembled |
| PTFE Luer Lock | TLL | | Yes if disassembled |
| SampleLock™ | SL | Integrated on/off valve | No |
| Fixed Needle | FN | Found on CTC C-Line and X-Type syringes | No |
| ChemSeal™ | C | 1/4"-28 UNF/threaded connection | No |

Needle Point Styles

| Point Style | Description | Application |
|--|---|---|
| 2  | 10–12° sharp, beveled, curved non-coring | Gas chromatography, septum piercing |
| 3  | Blunt, electro-polished | High performance liquid chromatography (HPLC) injection, thin layer chromatography (TLC), general liquid handling, controlled animal injections |
| 3T  | Blunt, electro-polished, coated with PTFE 19 mm from the tip | Thin layer chromatography (TLC) applications |
| 4  | Sharp 10–12° beveled needle | Life science/animal injections |
| 5  | Conical with side port for penetration without coring | Headspace, applications prone to needle clogging, causes minimal septum damage |
| AS  | Conical, non-coring designed to withstand multiple injections | Autosampler injection, pre-pierced septa |



Gas Chromatography Syringes

The invention of the Microliter syringe by Clark Hamilton in 1947 enabled the development of gas chromatography. “At that time there was no convenient way to introduce microliter (or even smaller) volumes of liquids into a gas chromatograph,” wrote Professor Georges Guiochon, Professor and Distinguished Scientist at University of Tennessee. “In fact, it is not an exaggeration to say that without the Hamilton syringes, gas chromatography could not have become everybody’s technique” [Chromatographia 15(6), 333 (1982)]. Injection into a gas chromatograph may be manual or automatic. In both cases, a microsyringe is required to introduce the sample. The choice of the correct syringe depends on the type of injector used.



Manual Split/Splitless Injection

A split/splitless injector consists of a heated chamber with a glass liner into which the sample is injected through the septum. A microsyringe is used to inject the sample through a rubber septum into a flash vaporizer chamber at the head of the column. The sample vaporizes to form a mixture of carrier gas, vaporized solvent and vaporized analytes. In the split mode, only a proportion of this mixture reaches the column but most exits through the split outlet. This avoids overloading the column. In the splitless mode, the split vent is closed so that the vaporized analyte passes onto the column. This mode is more sensitive and adequate for trace analysis.

Common syringe features for split/splitless injection include:

- ▶ Microliter syringes for liquid samples and Gastight syringes for gas and liquid samples
- ▶ Common volume range between 0.5 to 50 μL
- ▶ Needle with point style 2 to pierce the rubber septum
- ▶ Needle length of 51 mm to reach the middle of the glass liner. Splitless injection of small volumes may be performed with a 70 mm needle to deposit the sample close to the column entrance.

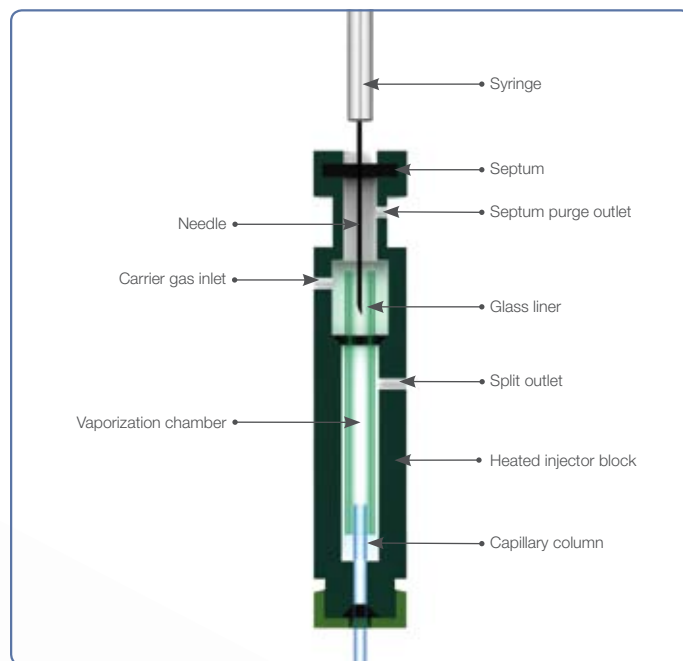
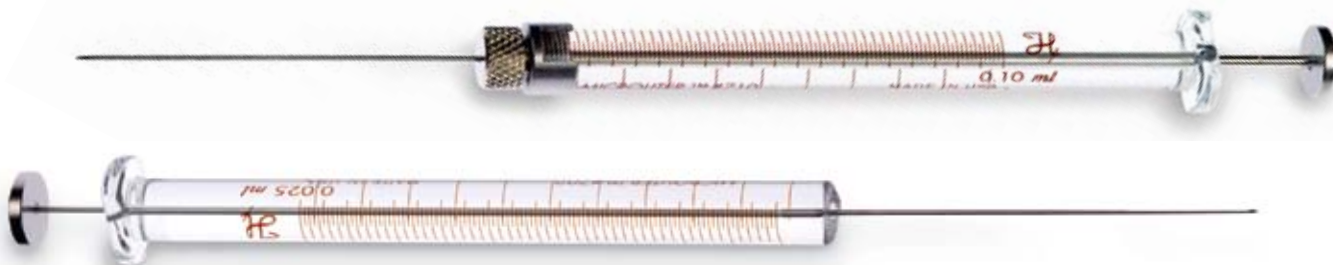

Illustration of a split/splitless injector



Injection of Liquid Samples

Syringes For Manual Injection of Liquid Samples

| Volume | 5 μL | 10 μL | 25 μL | 50 μL | 100 μL | 250 μL | 500 μL |
|---|-----------------|-----------------------|------------------|------------------|-------------------|-------------------|-------------------|
| Model | 75 | 701 | 702 | 705 | 710 | 725 | 750 |
| Gauge | 26s | 26s | 22s | 22s | 22s | 22s | 22 |
| Cemented Needle (N) Syringe (point style 2) | 87900 | 80300 80366 (6 pk) | 80400 | 80500 | 80600 | 80700 | 80800 |
| Removable Needle (RN) Syringe (point style 2) | 87930 | 80330 80336 (6 pk) | 80430 | 80530 | 80630 | 80730 | 80830 |
| Replacement Needle 6 pk (point style 2) | 7758-02 | 7758-02 | 7758-03 | 7758-03 | 7758-03 | 7779-03 | 7779-01 |

Note: Needles are 51 mm

Zero Dead Volume Syringes

| Volume | 0.5 μL | 1.0 μL | 2.0 μL | 5.0 μL |
|--|-------------------|-------------------|-------------------|-------------------|
| Model | 7000.5 | 7001 | 7002 | 7105 |
| Gauge | 25 | 25 | 25 | 24 |
| Knurled Hub (KH) Syringe (point style 2) | 86259 | 80135 | 88411 | 88011 |
| Standard Injection Spacer (25 mm) | 86201 | 86201 | 86201 | 86201 |

Note: Needles are 70 mm



Tech Tip

Choose a syringe with a removable needle if working with halogenated solvents.

Injection of Gas and Liquid Samples

Syringes For Manual Injection of Gas and Liquid Samples

| | | | | | |
|---|---------------|----------------|----------------|----------------|-----------------|
| Volume | 10 µL | 25 µL | 50 µL | 100 µL | 250 µL |
| Model | 1701 | 1702 | 1705 | 1710 | 1725 |
| Gauge | 26s | 22s | 22s | 22s | 22s |
| Cemented Needle (N) Syringe (point style 2) | 80000 | 80200 | 80900 | 81000 | |
| Cemented Needle (LTN) Syringe (point style 2) | | | | | 81100 |
| Removable Needle (RN) Syringe (point style 2) | 80030 | 80230 | 80930 | 81030 | 81130 |
| Replacement Needle 6 pk (point style 2) | 7758-02 | 7758-03 | 7758-03 | 7758-03 | 7779-03 |
| Volume | 500 µL | 1000 µL | 2500 µL | 5000 µL | 10000 µL |
| Model | 1750 | 1001 | 1002 | 1005 | 1010 |
| Gauge | 22 | 22 | 22 | 22 | 22 |
| Cemented Needle (LTN) Syringe (point style 2) | 81217 | 81317 | 81417 | 81517 | 81617 |
| Removable Needle (RN) Syringe (point style 2) | 81230 | 81330 | 81430 | 81530 | 81630 |
| Replacement Needle 6 pk (point style 2) | 7779-01 | 7779-01 | 7779-01 | 7779-01 | 7779-01 |

Note: Needles are 51 mm

Reinforced Plunger Syringes

| | | | | | |
|---|--------------|--------------|--------------|---------------|---------------|
| Volume | 10 µL | 25 µL | 50 µL | 100 µL | 250 µL |
| Model | 1801 | 1802 | 1805 | 1810 | 1825 |
| Gauge | 26s | 22s | 22s | 22s | 22s |
| Removable Needle (RN) Syringe (point style 2) | 84877 | 84880 | 84883 | 84886 | 84889 |
| Replacement Needle, 6 pk (point style 2) | 7758-02 | 7758-03 | 7758-03 | 7758-03 | 7779-03 |

Note: Needles are 51 mm



Reinforced Plunger Syringe



Adapter For Repeated Manual Injection

| | | | | | | |
|----------------------------------|------------|------------|------------|-------------|-------------|-------------|
| Volume | 10 μ L | 25 μ L | 50 μ L | 100 μ L | 250 μ L | 500 μ L |
| Model | 701/1701 | 702/1702 | 705/1705 | 710/1710 | 725/1725 | 750/1750 |
| Reproducibility (Chaney) Adapter | 14700 | 14725 | 14725 | 14725 | 14725 | 14725 |



Chaney Adapter

**Tech Tip**

Improve the reproducibility of multiple manual injections with the Chaney Adapter (p/n 14700 and 14725).



Manual On-Column Injection

On-column injection employs the direct introduction of the liquid sample into the column. This is very useful for the analysis of thermally unstable samples and avoids boiling point discrimination. On-column injection requires special syringes with the following features:

- ▶ Small outer diameter needles adjusted to the inner diameter of the column (0.17 mm needle for columns with 0.25 mm inner diameter, 32 gauge for columns with 0.32 mm inner diameter, and 26 gauge for columns with a 0.53 mm inner diameter)
- ▶ Longer needles tailored to pass through the injector and reach within the capillary column
- ▶ Point style 3 adapted to the typical septum of the on-column injector
- ▶ Small volume of 5 μL or 10 μL

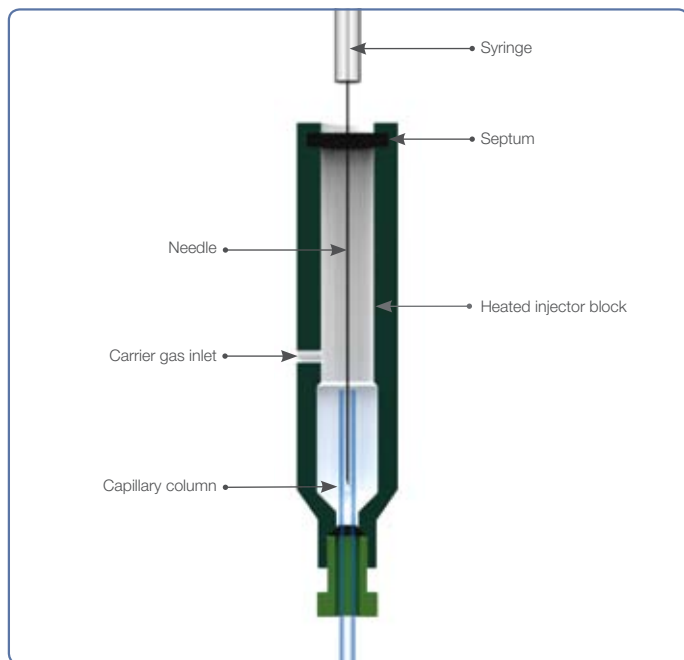

Illustration of an on-column injector



Syringes for On-Column Injection For Capillary Columns

| | | | |
|--|--------------------|--------------------|--------------------|
| Volume | 10 μL | 10 μL | 10 μL |
| Model | 701 | 701 | 701 |
| Gauge | 0.17 mm | 32 | 26s |
| Column I.D. | 0.25 mm | 0.32 mm | 0.53 mm |
| Fused Silica Needle Syringe (point style 3) | 87402 ¹ | 80308 ² | 80308 ² |

Note: Needles are 100 mm
 1) This is an RN needle
 2) These are stainless steel needles. Please specify gauge, length and point style.

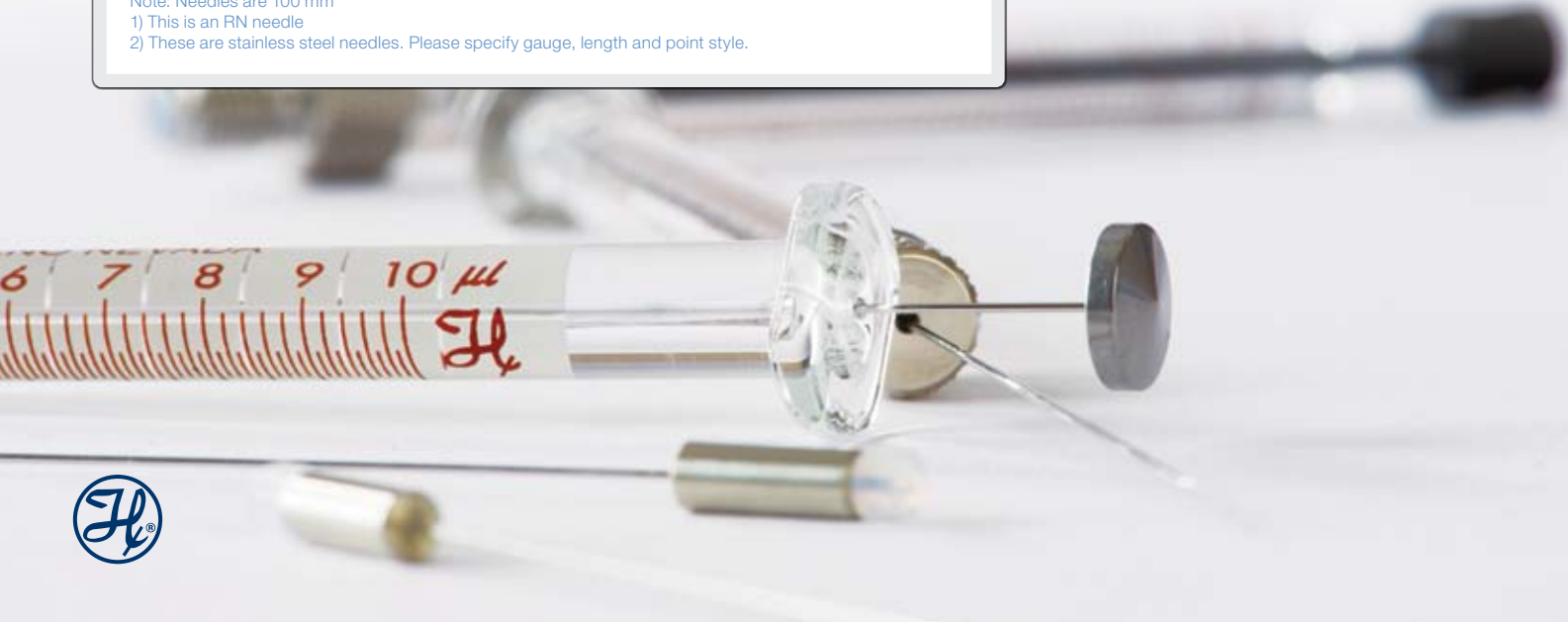

Gas Chromatography Autosampler Syringes

Autosamplers enable the automatic introduction of samples into the injector of the gas chromatograph (GC). Automatic injection has become very common as it improves reproducibility and speed.

Hamilton offers a wide range of autosampler syringes. The features of the autosampler syringes are adapted for an exact fit to a specific autosampler. The point style AS (for autosampler) has been specifically designed to withstand repeated penetration through the GC autosampler septa. Syringes for headspace injection usually have a point style 5, which is ideal for large gas volume injection. Autosampler syringes are available in two gauge types depending on the type of injector used.

| Gauge | Application |
|-------|---|
| 23s | Durable needle for Merlin MicroSeal™ septa and split/splitless injections |
| 26s | Versatile needle for all types of injections including split/splitless and on-column injections |

For a full list of all syringes available, visit www.hamiltoncompany.com/syringes

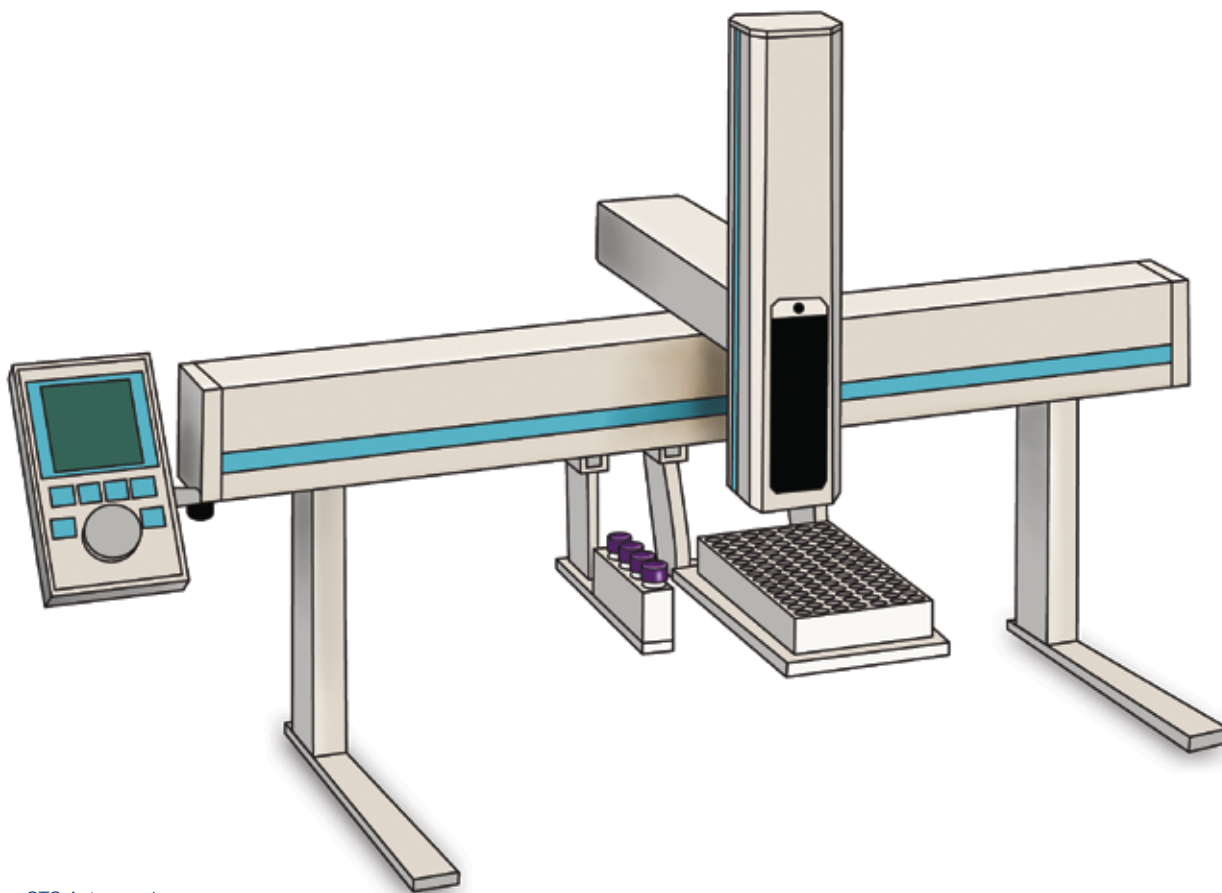

CTC Autosampler

CTC PAL[®] COMBI-xt and PAL[®] GC-xt Autosampler Syringes

CTC PAL[®] autosamplers are one of the most popular sampling devices on the market today for GC and headspace analyses. Customers rely on its ability to sample from many different vial and well types and on its ultimate platform flexibility. The syringe is at the heart of every injection that the GC PAL[®] system performs and CTC chose Hamilton to provide this critical component.

C-Line Syringes

C-Line syringes incorporate several unique design features that ensure superior performance. The innovative direct attachment design of the needle to the barrel eliminates contact between the sample solvent and adhesive, reducing carryover and ghost peaks. The inert plunger tip polymer provides enhanced solvent compatibility and longer lifetime.

C-Line PAL[®] COMBI-xt and PAL[®] GC-xt Liquid Injection Syringes



| Volume | 1.2 µL | 5 µL | 10 µL | 25 µL | 100 µL | 250 µL | 500 µL |
|---|---------------------|--------|-------------------------------|--------|---------------------|--------|--------|
| Model | 7701.2 | 75 | 701 | 1702 | 1710 | 1725 | 1750 |
| Gauge | 26 | 26s | 26s | 26s | 26s | 26 | 26 |
| Fixed Needle (FN) Syringe (point style AS) | 203185 ¹ | 203189 | 203205 203361 ² | 203043 | 203076 ³ | 203078 | 203080 |

Note: Needles are 51 mm

1) KH Termination

2) 23s gauge

3) Slimline syringe

Headspace Syringes for CTC PAL[®] Combi-xt

Modern GC headspace analysis requires injecting over large temperature ranges. Conventional headspace syringes on the market use a rubber O-ring sealed plunger which has a limited sealing performance at high temperatures due to varying thermal expansion between the different materials. The high dynamic HD-type syringe employs a unique spring in the plunger tip which compensates for the materials' different expansion coefficients, creating a better seal over a larger temperature range, and it also improves lifetime.



PAL[®] COMBI-xt Headspace Syringes

| Volume | 1000 µL | 1000 µL | 2500 µL | 2500 µL | 5000 µL | 5000 µL |
|--|---------|---------|---------|---------|---------|---------|
| Model | 1001 | 1001 | 1002 | 1002 | 1005 | 1005 |
| Gauge | 26 | 23 | 26 | 23 | 26 | 23 |
| Cemented Needle (LTN) Syringe (point style 5) | 203141 | 203082 | 203181 | 203084 | 203182 | 203086 |

Note: Needles are 51 mm



Agilent 7673, 7683, 7693 and 6850 Autosampler Syringes

Durable Syringes For Merlin Microseal™ Septa and Split/Splitless Injection

| Volume | 0.5 µL | 1 µL | 5 µL | 10 µL | 10 µL |
|---|--------|-------|-----------------------|-----------------------|-----------------------|
| Model | 7000.5 | 7001 | 75 | 701 | 1701 |
| Gauge | 23 | 23 | 23s | 23s | 23s |
| Cemented Needle (N) Syringe (point style AS) | | | 87987 87990 (6 pk) | 80387 80390 (6 pk) | 80080 80094 (6 pk) |
| Knurled Hub (KH) Syringe (point style AS) | 86276 | 80176 | | | |

Note: Needles are 43 mm

Universal Syringes For Split/Splitless and On-Column Injection

| Volume | 5 µL | 10 µL | 10 µL |
|---|-----------------------|-----------------------|-----------------------|
| Model | 75 | 701 | 1701 |
| Gauge | 23s–26s | 23s–26s | 23s–26s |
| Cemented Needle (N) Syringe (point style AS) | 87993 87994 (6 pk) | 80393 80391 (6 pk) | 80079 80096 (6 pk) |

Note: Needles are 43 mm

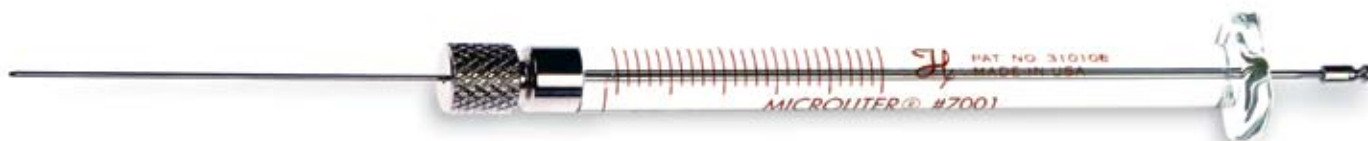

Versatile Syringes For All Types of Injections, Including On-Column Injection

| Volume | 0.5 µL | 5 µL | 10 µL |
|---|--------------------|-----------------------|-----------------------|
| Model | 7000.5 | 75 | 701 |
| Gauge | 26 | 26s | 26s |
| Cemented Needle (N) Syringe (point style AS) | 86274 ¹ | 87988 87989 (6 pk) | 80388 80389 (6 pk) |

Note: Needles are 43 mm
1) KH termination

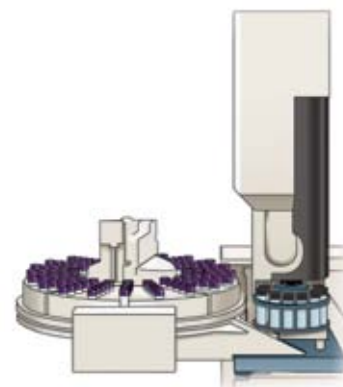

Agilent 7693 Autosampler

Thermo Scientific® Autosampler Syringes

AS 800, AS 2000 Syringes

| | |
|--------|-------|
| Volume | 10 µL |
| Model | 701 |
| Gauge | 26s |

| | |
|--|-------|
| Cemented Needle (N) Syringe (point style AS) | 80318 |
|--|-------|

Note: Needles are 80 mm

Headspace HS 250/500/850 Syringes

| | |
|--------|---------|
| Volume | 2500 µL |
| Model | 1002 |
| Gauge | 22 |

| | |
|---|--------|
| Cemented Needle (LTN) Syringe (point style 5) | 202660 |
|---|--------|

Note: Needles are 56 mm



Thermo Scientific® Finnigan AS 2000 Autosampler

AI/AS 3000 Tri Plus Syringes

| | | |
|--------|------|-------|
| Volume | 5 µL | 10 µL |
| Model | 75 | 701 |
| Gauge | 26s | 26s |

| | | |
|--|--------|--------|
| Cemented Needle (N) Syringe (point style AS) | 204051 | 204052 |
|--|--------|--------|

| | | |
|---|--------|--------|
| Cemented Needle (N) Syringe (point style 2) | 204000 | 204001 |
|---|--------|--------|

Note: Needles are 50 mm



Varian 8100/8200 Autosampler



Varian-Chrompack 8400 Autosampler

Varian-Chrompack Autosampler Syringes

Varian CP 8400/8410 CP9019/9050 Syringes

| | | |
|--------|------|-------|
| Volume | 5 µL | 10 µL |
| Model | 75 | 701 |
| Gauge | 26s | 26s |

| | | |
|---|-------|-------|
| Cemented Needle (N) Syringe (point style 2) | 87900 | 80300 |
|---|-------|-------|

| | | |
|--|--|-------|
| Cemented Needle (N) Syringe 6 pk (point style 2) | | 80366 |
|--|--|-------|

Note: Needles are 51 mm

Varian 8100/8200 Syringes

| | |
|--------|---------|
| Volume | 10 µL |
| Model | 701 |
| Gauge | 0.48 mm |

| | |
|---|--------|
| Removable Needle (RN) Syringe (point style 5) | 202880 |
|---|--------|

Note: Needles are 50.5 mm



Shimadzu Autosampler Syringes

Shimadzu AOC-9 Syringes

| | | |
|--------|-----------|------------|
| Volume | 5 μ L | 10 μ L |
| Model | 75 | 701 |
| Gauge | 26s | 26s |

| | | |
|--|-------|-------|
| Removable Needle (RN) Syringe (point style 2) | 87930 | 80330 |
|--|-------|-------|

Note: Needles are 51 mm

Shimadzu AOC-14/AOC-17/AOC-20 Syringes

| | | |
|--------|-----------|------------|
| Volume | 5 μ L | 10 μ L |
| Model | 75 | 701 |
| Gauge | 22s | 22s |

| | | |
|--|--------|--------|
| Removable Needle (RN) Syringe (point style 2) | 202630 | 202640 |
|--|--------|--------|

Note: Needles are 43 mm

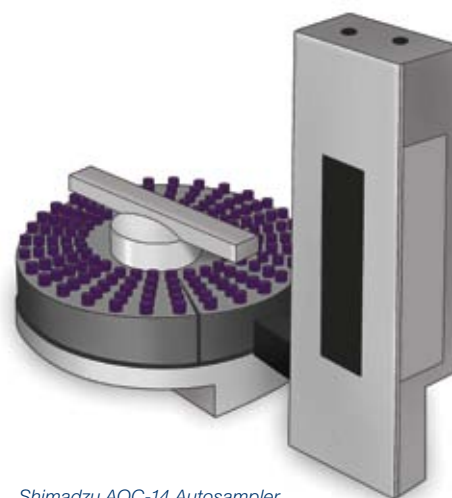

Shimadzu AOC-14 Autosampler



Liquid Chromatography Syringes

Hamilton manufactures a complete range of high performance liquid chromatography (HPLC) syringes and thin layer chromatography (TLC) syringes.

HPLC Syringes

HPLC syringes are especially designed for manual or automatic injection within high pressure ports. The needle is blunt and electro-polished to slide smoothly into the injection port reducing the wear on critical seals. The selection of the appropriate syringe for HPLC applications takes the following three aspects into account: the type of injection valve, the sample properties and the injection volume. The volume of the syringe should be adjusted to the volume of the injection. In partial loop filling, the injection volume should not be greater than half of the loop capacity. In complete loop filling, where the loop size sets the injection volume, the syringe capacity should be greater than twice the loop volume.

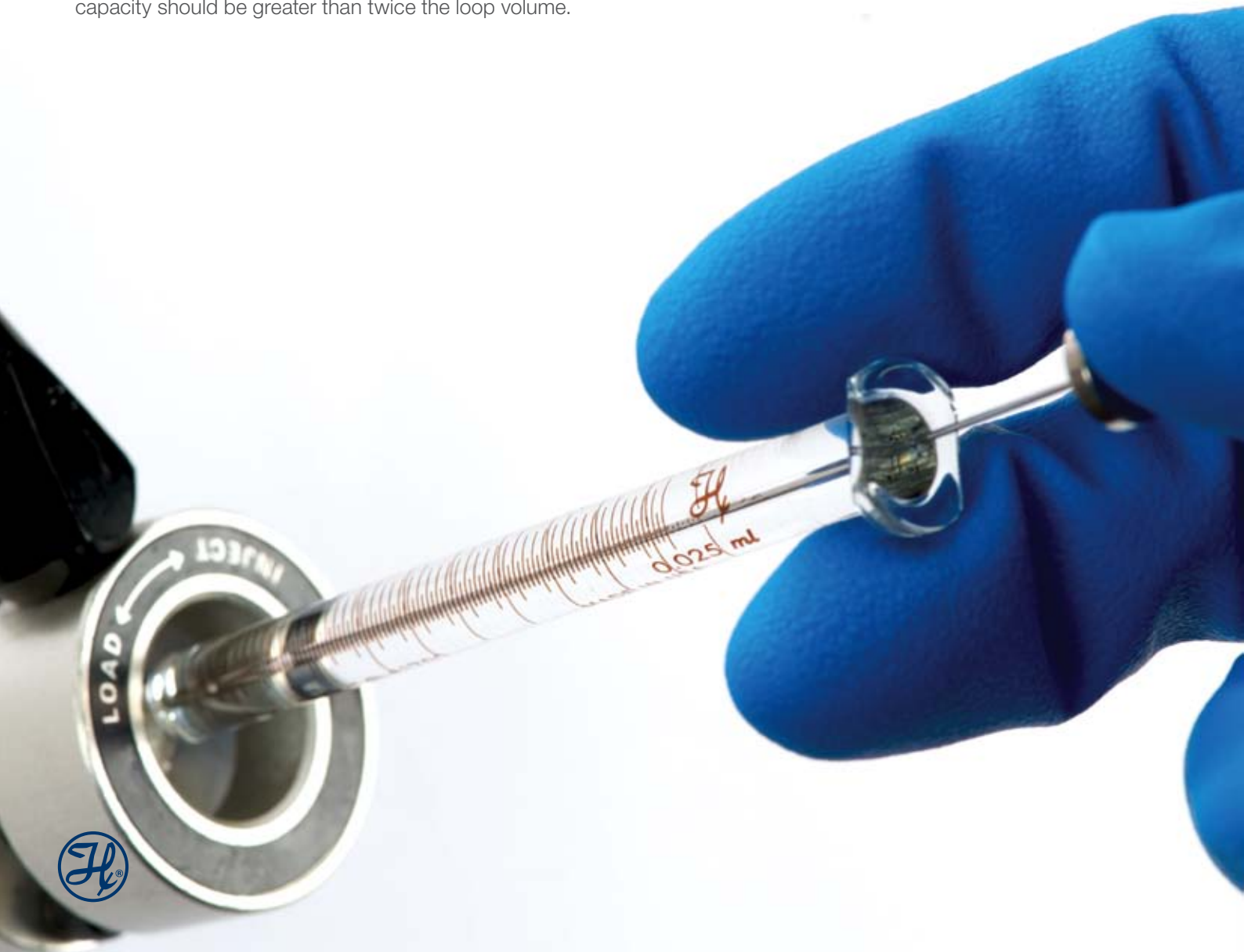

Rheodyne®, Valco®, Beckman Coulter, Altex and SSI Injection Valve Syringes



Gastight Syringes For Aqueous Samples

| Volume | 10 µL | 25 µL | 50 µL | 100 µL | 250 µL | 500 µL | 1000 µL |
|--|---------|---------|---------|---------|--------------------|---------|---------|
| Model | 1701 | 1702 | 1705 | 1710 | 1725 | 1750 | 1001 |
| Gauge | 22s | 22s | 22s | 22s | 22s | 22 | 22 |
| Cemented Needle (N) Syringe (point style 3) | | 80275 | 80975 | 81075 | | | |
| Cemented Needle (LTN) Syringe (point style 3) | | | | | 81175 | 81216 | 81316 |
| Removable Needle (RN) Syringe (point style 3) | 80065 | 80265 | 80965 | 81065 | 81165 ¹ | 81265 | 81365 |
| Replacement Needle 6 pk (point style 3) | 7770-01 | 7770-01 | 7770-01 | 7770-01 | 7780-03 | 7780-04 | 7780-04 |

Note: Needles are 51 mm
1) 22 gauge needle



Microliter Syringes For Volatile Organic Samples

| Volume | 10 µL | 25 µL | 50 µL | 100 µL | 250 µL | 500 µL |
|--|-------|-------|-------|--------|--------|--------|
| Model | 701 | 702 | 705 | 710 | 725 | 750 |
| Gauge | 22s | 22s | 22s | 22s | 22 | 22 |
| Cemented Needle (N) Syringe (point style 3) | 80365 | 80465 | 80565 | 80665 | 80765 | 80865 |

Note: Needles are 51 mm



Tech Tip

Gastight syringes have a polymer tipped plunger, often PTFE, which essentially wipes the interior of the syringe barrels. This reduces the risk of deposition on the barrel which may cause cross-contamination or plunger seizing.

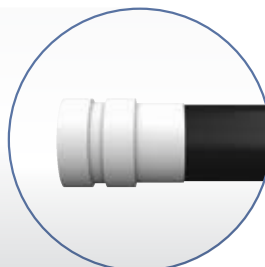

Valco® VISF-1 Valve Syringes



Valco® VISF-1 Injection Valve Syringes

| | | | | | | |
|---|---------|---------|---------|----------------------|---------|---------|
| Volume | 25 µL | 50 µL | 100 µL | 250 µL | 500 µL | 1000 µL |
| Model | 1702 | 1705 | 1710 | 1725 | 1750 | 1001 |
| Gauge | 22s | 22s | 22s | 22s | 22 | 22 |
| Removable Needle (RN) Syringe (point style 3) | 80231 | 80931 | 81031 | 81131 | 81231 | 81331 |
| Replacement Needle 6 pk (point style 3) | 7787-01 | 7787-01 | 7787-01 | 7806-02 ¹ | 7787-02 | 7787-02 |

Note: Needles are 19 mm
1) Please specify length and point style

Adapter For Repeated Manual Injection

| | | | | | | |
|----------------------------------|----------|----------|----------|----------|----------|----------|
| Volume | 10 µL | 25 µL | 50 µL | 100 µL | 250 µL | 500 µL |
| Model | 701/1701 | 702/1702 | 705/1705 | 710/1710 | 725/1725 | 750/1750 |
| Reproducibility (Chaney) Adapter | 14700 | 14725 | 14725 | 14725 | 14725 | 14725 |



Tech Tip

Improve the reproducibility of multiple manual injections with the Chaney adapter (p/n 14700 and 14725).

The Power of Polymeric HPLC Columns

Hamilton was the first to offer pressure-stable HPLC columns, and the company now features a wide range of column retention selectivities and performance benefits. Hamilton offers 19 different polymer-based HPLC columns for reversed phase, anion exchange, cation exchange and ion exclusion separations. Hamilton's polymeric HPLC columns combine the inertness and pH stability of polymeric supports with the pressure stability and durability of silica-based columns. Two silica-based C8 and C18 columns are also available for reversed phase separations.



Thin Layer Chromatography

The point of the needle of a thin layer chromatography (TLC) syringe is covered with a PTFE coating (point style 3T). The coating reduces the surface tension between the needle and the liquid making it ideal for reproducible sample spotting.

Thin Layer Chromatography Syringes

| | | | | |
|---|------------|------------|------------|-------------|
| Volume | 10 μ L | 25 μ L | 50 μ L | 100 μ L |
| Model | 1701 | 1702 | 1705 | 1710 |
| Gauge | 26s | 22s | 22 | 22 |
| Cemented Needle (N) Syringe (point style 3T) | 80050 | 80250 | 80950 | 81050 |

Note: Needles are 51 mm

For a full list of all syringes available,
visit www.hamiltoncompany.com/syringes

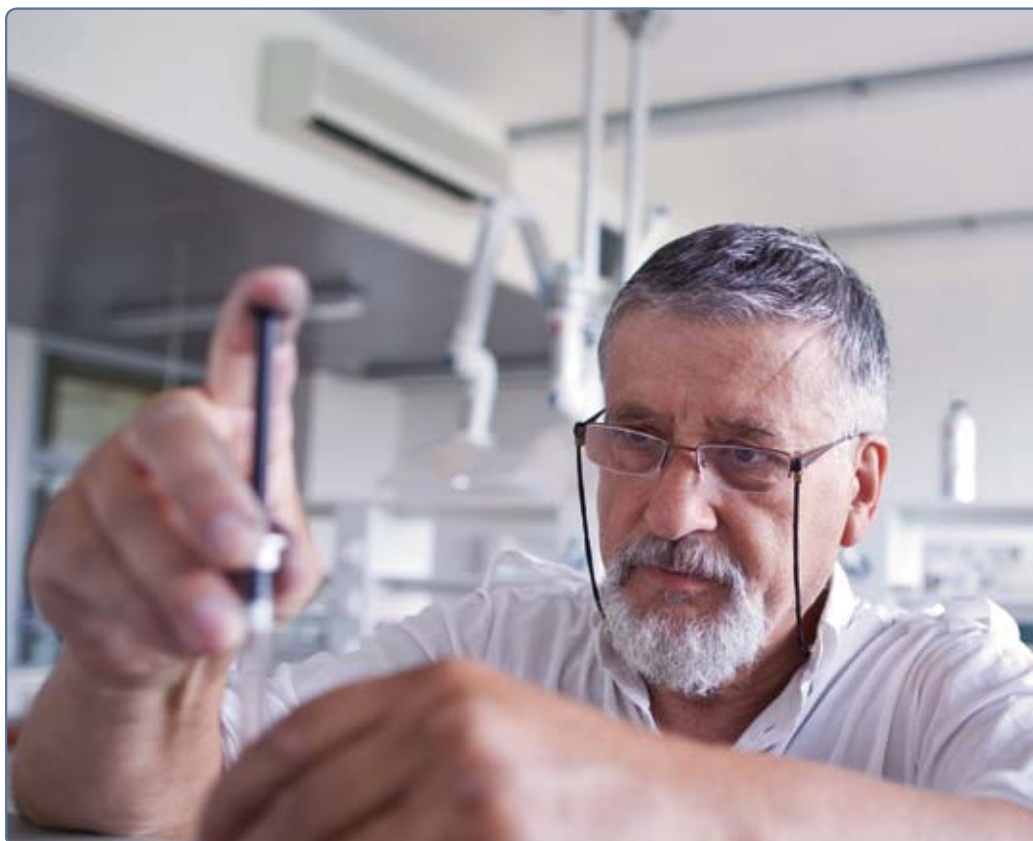

HPLC Autosampler Syringes

HPLC autosamplers enable the automatic introduction of samples into the sample loop as well as a certain amount of sample preparation. Automatic injection has become very common, as it provides improved reproducibility and speed. Hamilton offers a wide range of HPLC autosampler syringes. The features of the autosampler syringes are adapted for an exact fit to a specific autosampler.

CTC PAL[®] HTC-xt, HTS-xt and HTX-xt Autosampler Syringes

CTC PAL[®] autosamplers are one of the most popular sample processing systems for HPLC analyses. Customers rely on its ability to sample from many different vial and well types and on its ultimate platform flexibility. The syringe is at the heart of every injection that the LC PAL[®] system performs and CTC chose Hamilton to provide this critical component.



C-Line Syringes

C-Line syringes incorporate several unique design features that ensure superior performance. The innovative direct attachment design of the needle to the barrel eliminates contact between the sample solvent and adhesive reducing carryover and ghost peaks. The inert plunger tip polymer provides enhanced solvent compatibility and longer lifetime.

C-Line CTC PAL® HTC-xt, HTS-xt and HTX-xt Syringes

| Volume | 10 µL | 25 µL | 100 µL | 250 µL | 500 µL | 1000 µL | 2500 µL | 5000 µL |
|--|---------------------|--------|---------------------|--------|--------|---------------------|---------------------|---------------------|
| Model | 1701 | 1702 | 1710 | 1725 | 1750 | 1001 | 1002 | 1005 |
| Gauge | 22s | 22s | 22s | 22 | 22 | 22 | 22 | 22 |
| Fixed Needle (FN) Syringe (point style 3) | 203194 ² | 203075 | 203077 ² | 203079 | 203349 | 203081 ¹ | 203083 ¹ | 203085 ¹ |

Note: Needles are 51 mm

1) LTN termination

2) Slimline syringe



X-Type Syringes

Hamilton, together with CTC Analytics, has developed X-Type syringes with near zero carryover and a long-lasting plunger tip to meet the requirement of high-throughput life science analytical syringes for sensitive applications. The syringe glass barrel is polished and sealed for inertness and enhanced lifetime. The needle is deactivated to reduce sample adsorption. Tests with critical samples like phospholipids, basic molecules and peptides have shown that carryover and absorption can be reduced depending on the sample. The plunger's life cycle is also improved.

X-Type Syringes For Sensitive Chromatography Applications

| Volume | 25 µL | 100 µL | 100 µL |
|--|--------|--------|--------|
| Model | 1702 | 1710 | 1710 |
| Gauge | 22s | 22 | 22s |
| Fixed Needle (FN) Syringe (point style 3) | 204475 | 204400 | 204452 |

Note: Needles are 51 mm

A guide to syringe terminations and needle points can be found on page 4.

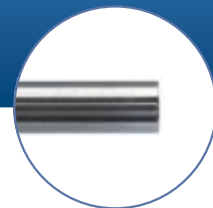

PREP. ROZT. LEU-ENKE
10 mL A.CN
10 mL H₂O
10 mL HCOOH
10 mL LEU-ENKF
(1 mg/mL)



Agilent/Varian Autosampler Syringes

Agilent 1290 Infinity LC Injector HTC/HTS Syringes

| Volume | 10 µL | 25 µL | 100 µL | 250 µL | 500 µL | 1000 µL | 2500 µL | 5000 µL |
|---|---------------------|--------|---------------------|--------|--------|---------------------|---------------------|---------------------|
| Model | 1701 | 1702 | 1710 | 1725 | 1750 | 1001 | 1002 | 1005 |
| Gauge | 22s | 22s | 22s | 22 | 22 | 22 | 22 | 22 |
| Fixed Needle (FN) Syringe (point style 3) | 203194 ¹ | 203075 | 203077 ¹ | 203079 | 203349 | 203081 ² | 203083 ² | 203085 ² |

Note: Needles are 51 mm

1) Slimline syringe

2) LTN termination

Varian Prostar 410/420/430 Syringes

| Volume | 25 µL | 100 µL | 250 µL | 500 µL | 1000 µL | 2500 µL |
|----------------------|-----------|-----------|-----------|-----------|-----------|-----------|
| Model | 1702 | 1710 | 1725 | 1750 | 1001 | 1002 |
| Gauge | No needle | No needle | No needle | No needle | No needle | No needle |
| ChemSeal (C) Syringe | 62161-01 | 54658-01 | 54659-01 | 54660-01 | 54661-01 | 54662-01 |



Spark Holland Midas Autosampler

Thermo Scientific® Autosampler Syringes

AS 100/300 and AS 1000/3000/3500 Syringes

| Volume | 250 µL | 500 µL | 1000 µL | 2500 µL | 5000 µL |
|----------------------|-----------|-----------|-----------|-----------|-----------|
| Model | 1725 | 1750 | 1001 | 1002 | 1005 |
| Gauge | No needle | No needle | No needle | No needle | No needle |
| ChemSeal (C) Syringe | 202145 | 202192 | 81360 | 81460 | 81560 |

SP 8780/8875/8880 Syringes

| Volume | 250 µL | 2500 µL |
|----------------------|-----------|-----------|
| Model | 1725 | 1002 |
| Gauge | No needle | No needle |
| ChemSeal (C) Syringe | 202145 | 81460 |



Thermo Scientific® AS 3000 Autosampler

Spark Holland Autosampler Syringes

The Hamilton Spark Holland syringe line works with the following manufacturers' autosamplers:

- ▶ Spark Holland Midas, Triathlon, Endurance and Alias
- ▶ Antec AS 100 and AS 110
- ▶ Dionex ESA Model 542, 540 and 540MT
- ▶ Beckman Coulter 508
- ▶ Grace/Alltech Model 580

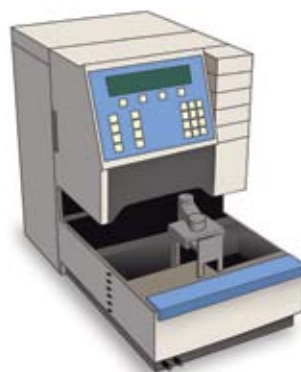

Spark Holland Endurance Autosampler



Spark Holland Autosampler Syringes

| | | | | | | |
|----------------------|-----------|-----------|-----------|-----------|-----------|-----------|
| Volume | 25 µL | 100 µL | 250 µL | 500 µL | 1000 µL | 2500 µL |
| Model | 1702 | 1710 | 1725 | 1750 | 1001 | 1002 |
| Gauge | No needle | No needle | No needle | No needle | No needle | No needle |
| ChemSeal (C) Syringe | 62161-01 | 54658-01 | 54659-01 | 54660-01 | 54661-01 | 54662-01 |

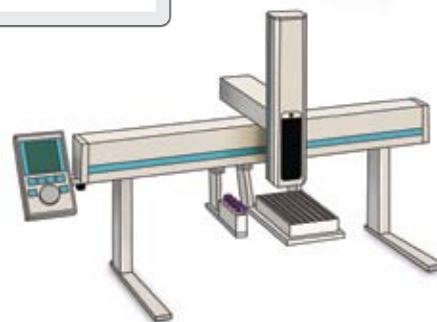

Waters® 2777 Sample Manager

Waters® Autosampler Syringes

Waters® 2777 Sample Manager Syringes

| | | | | | | | | |
|---|---------------------|--------|---------------------|--------|--------|---------------------|---------------------|---------------------|
| Volume | 10 µL | 25 µL | 100 µL | 250 µL | 500 µL | 1000 µL | 2500 µL | 5000 µL |
| Model | 1701 | 1702 | 1710 | 1725 | 1750 | 1001 | 1002 | 1005 |
| Gauge | 22s | 22s | 22s | 22 | 22 | 22 | 22 | 22 |
| Fixed Needle (FN) Syringe (point style 3) | 203194 ¹ | 203075 | 203077 ¹ | 203079 | 203349 | 203081 ² | 203083 ² | 203085 ² |

Note: Needles are 51 mm
 1) Slimline syringes
 2) LTN termination

Waters® 2707 Autosampler Syringes

| | | | | | | |
|----------------------|-----------|-----------|-----------|-----------|-----------|-----------|
| Volume | 25 µL | 100 µL | 250 µL | 500 µL | 1000 µL | 2500 µL |
| Model | 1702 | 1710 | 1725 | 1750 | 1001 | 1002 |
| Gauge | No needle | No needle | No needle | No needle | No needle | No needle |
| ChemSeal (C) Syringe | 62161-01 | 54658-01 | 54659-01 | 54660-01 | 54661-01 | 54662-01 |



PerkinElmer® Autosampler Syringes

Series 225, Flexar® FX-10/FX-15 Syringes

| | | | | | | |
|----------------------|-----------|-----------|-----------|-----------|-----------|-----------|
| Volume | 25 µL | 100 µL | 250 µL | 500 µL | 1000 µL | 2500 µL |
| Model | 1702 | 1710 | 1725 | 1750 | 1001 | 1002 |
| Gauge | No needle | No needle | No needle | No needle | No needle | No needle |
| ChemSeal (C) Syringe | 62161-01 | 54658-01 | 54659-01 | 54660-01 | 54661-01 | 54662-01 |

Series 200 Syringes

| | | | | | |
|----------------------|-----------|-----------|-----------|-----------|-----------|
| Volume | 50 µL | 250 µL | 500 µL | 1000 µL | 2500 µL |
| Model | 1705 | 1725 | 1750 | 1001 | 1002 |
| Gauge | No needle | No needle | No needle | No needle | No needle |
| ChemSeal (C) Syringe | 80962 | 81162 | 81262 | 81360 | 81460 |



PerkinElmer® Series 225 Autosampler



Sample Preparation and Liquid Handling

Syringe pumps are the most accurate and precise tool for liquid handling. For any syringe pump, the key in achieving the most accurate dispenses is the syringe. Hamilton has a 40-year proven history of designing and manufacturing syringe pumps. With the recent launch of the Microlab® 600, Hamilton's innovation has been brought a step further. The new generation of semi-automated diluters and dispensers are designed for ease of use thanks to the full-color touchscreen interface. The Microlab 600 is used in analytical laboratories performing sample dilution and aliquoting in fields such as pharmaceutical, mining or environmental analysis.



Syringes For the Hamilton Microlab 600

Microlab 600 Syringes

| Volume | 10 μ L | 25 μ L | 50 μ L | 100 μ L | 250 μ L | 500 μ L |
|---------------------------|------------|------------|------------|-------------|-------------|-------------|
| Bubble Free Prime Syringe | 59000-05 | 59000-10 | 59000-15 | 59000-20 | 59000-25 | 59000-30 |
| Volume | 1 mL | 2.5 mL | 5 mL | 10 mL | 25 mL | 50 mL |
| Bubble Free Prime Syringe | 59000-35 | 59000-40 | 59000-45 | 59000-50 | 59000-55 | 59000-60 |
| SaltLine™ Syringe | 208335 | | 208336 | 208337 | | |

Syringes For Laboratory Syringe Pumps

Laboratory syringe pumps, which may be manufactured by companies such as Harvard Apparatus, KD Scientific, Inc., Kent Scientific Corporation, cetoni and others, are common for microfluidics, drug/nutritional infusions, electrospinning, mass spectrometer calibration, cell feeding and many other applications. There are several infusion pump manufacturers, but one thing is consistent—when a precise flow is critical, all manufacturers turn to Hamilton syringes. Our syringes are available in volumes from 0.5 μ L to 100 mL and a variety of terminations to serve almost any application. The PTFE Luer Lock (TLL) termination is extremely common as it provides the most flexible options for connection of tubing.

Laboratory Syringe Pump Syringes

| Volume | 50 μ L | 100 μ L | 250 μ L | 500 μ L | 1 mL | 2.5 mL |
|----------------------------------|-------------|-------------|-------------|-------------|-------------|-------------|
| Model | 1705 | 1710 | 1725 | 1750 | 1001 | 1002 |
| Luer Lock (TLL) Syringe | 80920 | 81020 | 81120 | 81220 | 81320 | 81420 |
| SaltLine Luer Lock (TLL) Syringe | | | 203220 | 203230 | 203240 | 203250 |
| Volume | 5 mL | 10 mL | 25 mL | 50 mL | 100 mL | |
| Model | 1005 | 1010 | 1025 | 1050 | 1100 | |
| Luer Lock (TLL) Syringe | 81520 | 81620 | 82520 | 85020 | 86020 | |
| SaltLine Luer Lock (TLL) Syringe | 203260 | 203270 | | | | |

Tubing Assemblies For Luer Lock and Luer Tip Syringes

| Hub | No hub | 1x Female Luer | 1x Female Luer |
|-----------------|---------------|----------------|----------------|
| Length | Custom | 300 mm | Custom |
| Material | PTFE | PTFE | PTFE |
| Gauge 12 | 20912 | 90612 | 90662 |
| Gauge 18 | 20918 | 90618 | 90668 |
| Gauge 22 | 20922 | 90622 | 90672 |
| Gauge 30 | 20930 | 90630 | 90680 |



Tech Tip

SaltLine

SaltLine syringes have a highly inert and non-corrosive plunger as well as a particularly resistant ultra-high molecular weight poly-ethylene (UHMWPE) plunger tip, which considerably enhances the syringe lifetime with salt and acid solutions. SaltLine syringes are recommended for life science applications with salty buffers, mining applications with acids or trace metal analysis.

Automate Your Handheld Pipetting

The Microlab 600 is a highly precise syringe pump that specializes in tasks too small to automate but too large to reliably accomplish by hand, making it invaluable to labs looking to increase efficiency and consistency while reducing cost and wasted buffer. It uses a positive displacement system to provide better than 99% accuracy, independent of a liquid's viscosity, vapor pressure, and temperature—even with harsh chemicals.

With its simple touchscreen interface, built-in wizards and custom method tool, it helps every laboratory work smarter. The free compliance software package on Advanced models features enhanced security options that adhere to CFR 21 Part 11 and FDA GMP/GLP requirements.



For more information on the Microlab 600 benefits your lab, visit www.hamiltoncompany.com/microlab600



Life Science Syringes

Hamilton Company offers a wide variety of specialized syringes for life science applications. From custom needles to specialized animal injections and gel loading syringes, Hamilton has a solution for your precision liquid handling life science applications.

General Animal Injections

Hamilton features a selection of small volume syringes and small gauge needles that can be used for performing injections on lab animals.

Small Hub Removable Needle Syringes and Custom Needles

Animal injections require a variety of different needle lengths and gauges depending on the target of the injection. For this purpose, Hamilton provides a variety of custom needle options between 27 and 34 gauge. These needles are combined with our small volume Removable Needle syringes to create the perfect application specific syringe. The most common point style for animal injection is point style 4 which comes standard with a sharp 12° beveled tip. If the vessel you are targeting is extremely small, it is possible to select a custom bevel between 12° and 60° to best suit the application. If a blunt point is desired, select point style 3. To minimize needle flexing it is recommended to choose the shortest length possible. The ideal length is typically 13 mm and shorter.

General Animal Injection Syringes

| Volume | 5 µL | 10 µL | 25 µL | 50 µL | 100 µL |
|---|---------|---------|---------|---------|---------|
| Model | 75 | 1701 | 1702 | 1705 | 1710 |
| Removable Needle (RN) Syringe (no needle included) | 7634-01 | 7653-01 | 7654-01 | 7655-01 | 7656-01 |

Custom Stainless Steel Needles

| Gauge | 27 | 28 | 29 | 30 | 31 | 32 | 33 | 34 |
|------------------|-------------|-------------|-------------|-------------|-------------|-------------|-------------|---------------------|
| O.D. X I.D. (mm) | 0.41 x 0.21 | 0.36 x 0.18 | 0.34 x 0.18 | 0.31 x 0.16 | 0.26 x 0.13 | 0.24 x 0.11 | 0.21 x 0.11 | 0.16 x 0.05 |
| Small RN Needle | 7803-01 | 7803-02 | 7803-06 | 7803-07 | 7803-03 | 7803-04 | 7803-05 | 207434 ¹ |

Note: Please specify length and point style when ordering
¹) This needle should be used with a Gastight syringe

For a full list of all syringes available,
 visit www.hamiltoncompany.com/syringes



Neuroscience Injections

Introducing Neuros™ Syringes

Hamilton Neuros syringe technology provides unprecedented functionality for controlled animal injections. The Neuros accurately dispenses volumes between 50 nL to 100 µL through an ultrafine needle with a blunt point (point style 3). Developed specifically for neuroscience applications, the Neuros enables the delivery of microvolumes to an exact location while minimizing injection site damage. Neuros syringes come with two types of protective needle sleeves. The sleeve with a blind stop is perfect for cannulated applications and ensures targeted administration with an adjustable penetration depth. The version without a blind stop works best with stereotaxic holders. Both types provide an adjustable needle exposure of 0 to 20 mm.

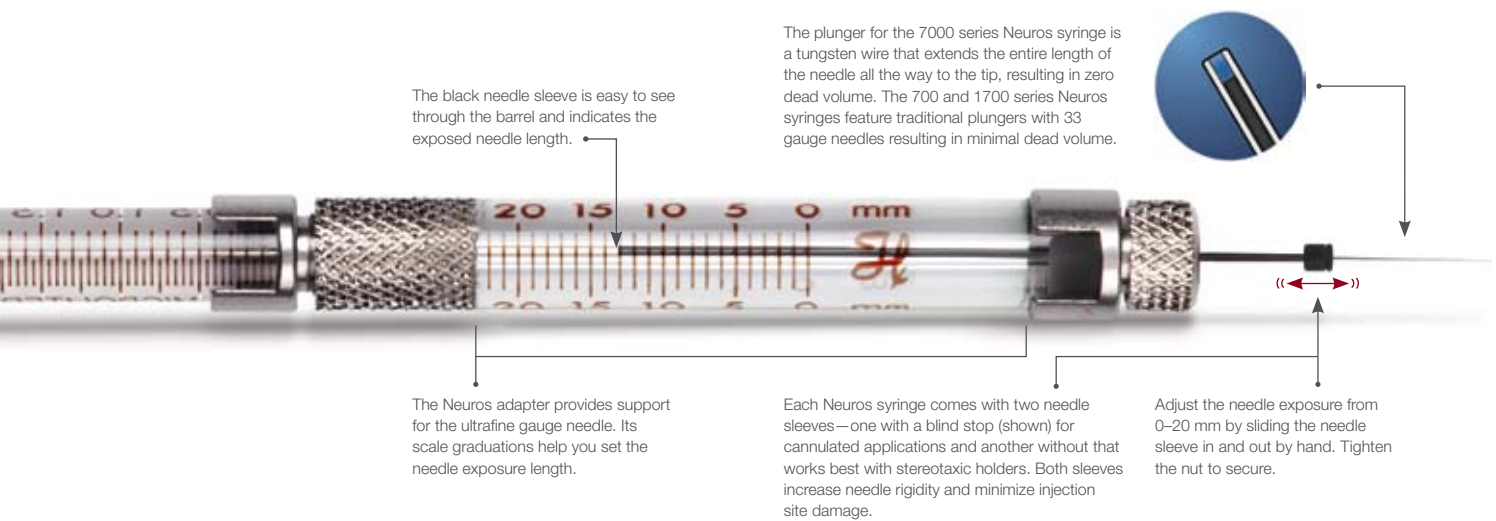

Neuros Syringes

| Volume | 0.5 µL | 1 µL | 2 µL | 5 µL | 10 µL | 25 µL | 50 µL | 100 µL |
|--------------------------------|----------|----------|----------|----------|----------|----------|----------|----------|
| Model | 7000.5 | 7001 | 7002 | 75 | 1701 | 1702 | 1705 | 1710 |
| Gauge | 32 | 32 | 30 | 33 | 33 | 33 | 33 | 33 |
| Neuros Syringe (point style 3) | 65457-01 | 65458-01 | 65459-01 | 65460-02 | 65460-05 | 65460-10 | 65460-15 | 65460-20 |

Note: The exposed needle length is adjustable from 0 to 20 mm

For more information on Neuros syringes, visit www.hamiltoncompany.com/neuros



Glass Capillary Needles

Glass capillary needles offer several distinct advantages over traditional stainless steel needles. Glass needles can be pulled to form a much finer point, generally smaller than 50 μm . Even with such a small outer diameter, the glass remains rigid and resists dulling. Unlike a beveled needle, the liquid exits out the point of the needle. For several applications these features result in less damage to the animal and an overall better result for the researcher.

To simplify the use of glass capillary needles, Hamilton provides a compression fitting for 1 mm O.D. capillary tubing. When tightened into a small hub Removable Needle syringe, the compression fitting grabs onto the outside of the glass tubing to secure it to the syringe. Next, a priming kit is used to fill the syringe and needle with buffer or mineral oil, and the system is ready for use.

RN Compression Fitting 1 mm (p/n 55750-01)

Adapts a small hub Removable Needle (RN) termination to a 1 mm pulled glass needle.



Glass Needle Compression Fittings

| | |
|--|----------|
| Compression Fittings (1 mm Glass Needles) | 55750-01 |
| Syringe Priming Kit | PRMKIT |

Note: Hamilton does not sell glass needles

Compatible Syringes For 1 mm Glass Needle Compression Fittings

| Volume | 5 μL | 10 μL | 25 μL | 50 μL | 100 μL |
|---|-----------------|------------------|------------------|------------------|-------------------|
| Model | 75 | 1701 | 1702 | 1705 | 1710 |
| Removable Needle (RN) Syringe (no needle included) | 7634-01 | 7653-01 | 7654-01 | 7655-01 | 7656-01 |

Remote Dispensing From a Syringe

There are applications where extending the fluid line between the syringe and needle is required. An example of this is using an infusion pump in combination with a stereotaxic frame. To facilitate this, Hamilton provides compression fittings that are compatible with 1/16 inch PEEK tubing. PEEK tubing is often used for HPLC and was chosen for this purpose because of its high pressure rating. When dispensing extremely small volumes, it is critical to choose tubing that will not flex during the dispense. Flexible tubing has a serious impact on the precision and reproducibility of a dispense.

The compression fitting enables the connection of PEEK tubing to any small hub Removable Needle syringe. Then a small RN coupler connects to the other end of the tubing and to the desired needle. After, the RN coupler can be mounted into the traditional syringe holder for the stereotaxic frame.

RN Compression Fitting 1/16 inch (p/n 55751-01)

Adapts a small hub Removable Needle (RN) termination to 1/16 inch PEEK tubing.



Dual Small Hub RN Coupler (p/n 55752-01)

Connects any small hub RN connection to another small hub RN connection.

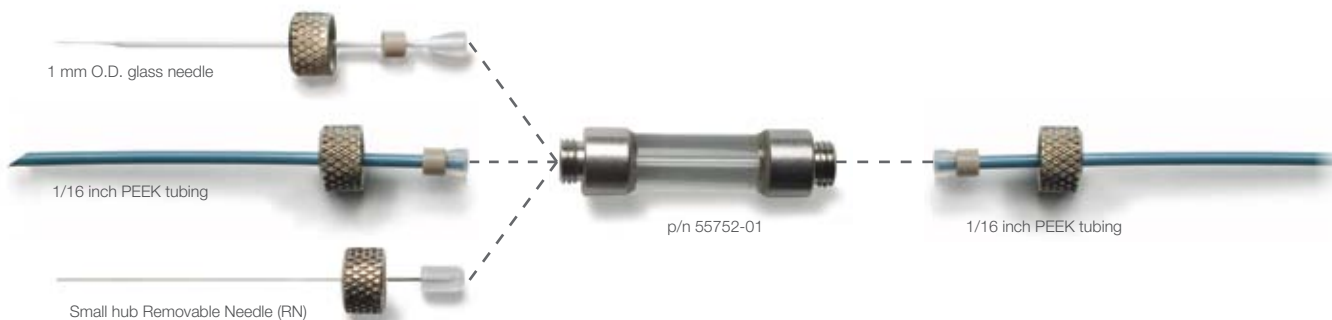

Compression Fittings For Remote Injections

| | |
|--|----------|
| Compression Fittings (1 mm Glass Needles) | 55750-01 |
| Compression Fittings (1/16 inch PEEK Tubing) | 55751-01 |
| Dual RN Coupler | 55752-01 |
| Syringe Priming Kit | PRMKIT |

Note: Hamilton does not sell PEEK tubing or glass needles

Compatible Syringes For Remote Injection Compression Fittings

| Volume | 5 μ L | 10 μ L | 25 μ L | 50 μ L | 100 μ L |
|---|-----------|------------|------------|------------|-------------|
| Model | 75 | 1701 | 1702 | 1705 | 1710 |
| Removable Needle (RN) Syringe (no needle included) | 7634-01 | 7653-01 | 7654-01 | 7655-01 | 7656-01 |

Stereotaxic Infusion Pumps

To improve control over injection rate a variety of stereotaxic mounted infusion pumps are available for Hamilton syringes. These pumps typically fit all standard Hamilton syringes from 0.5 to 500 μ L and can achieve flow rates as low as 3.66 pL/min. These pumps attach to the flange and barrel allowing for the use of almost any needle length and termination including the new Hamilton Neuros Syringes. Check with the manufacturer of your infusion pump for syringe compatibility.



Genomics and Biochemistry

Single and Multi-Channel Gel Loading Syringes

Hamilton Single and Multi-channel Gel Loading Syringes easily and accurately transfer up to eight DNA samples to sequencing gels for electrophoresis, to another microwell plate for duplicate analysis, or to nylon membranes for visualization. A single DNA syringe is also available for individual transfers.

Three different needle specifications allow either loading of samples into thin sequencing gel wells that are 0.2, 0.3 or 0.4 mm or larger, or directly onto the top of the sequencing gel. The standard needle spacing of 9 mm allows spotting between the gel plates using most square or sharktooth combs with a microwell format. An adjustable stop collar allows you to pre-set the volume anywhere between 0.2 μL to 10 μL .

Adjustable Multi-Channel Gel Loading Syringes

| | |
|---------------|------------------|
| Volume | 10 μL |
| Gel Thickness | 0.2 mm |
| Well Spacing | 9–10.8 mm |

| | |
|--|-------|
| Removable Needle (RN) Eight Channel Syringe (point style 3) | 84611 |
| Replacement Needle 4 pk (point style 3) | 78633 |

Gel Loading Syringes

| Volume | 10 μL | 10 μL | 10 μL |
|---------------|------------------|------------------|------------------|
| Gel Thickness | 0.2 mm | 0.3 mm | 0.4 mm |
| Well Spacing | 9 mm | 9 mm | 9 mm |

| | | | |
|--|-------|-------|-------|
| Cemented Needle (N) Single Channel Syringe (point style 3) | 80081 | 84505 | 84504 |
| Cemented Needle (N) Eight Channel Syringe (point style 3) | 84511 | 84503 | 84502 |
| Cemented Needle (N) Replacement Syringe | 80023 | 80022 | 80021 |



Gel Loading Syringe



Terasaki Dispenser

The multi-syringe dispenser accurately dispenses six samples simultaneously up to 50 times with the press of a lever. It has been designed for rapid filling of 60 well HLA/Terasaki plates with 6.35 mm well spacing.

Terasaki Dispenser

| | | | | | |
|---|-------------------|------------------|-------------------|-------------------|-------------------|
| Volume | 25 μL | 50 μL | 100 μL | 250 μL | 500 μL |
| Model | 1702 | 1705 | 1710 | 1725 | 1750 |
| Volume to Dispense | 0.5 μL | 1 μL | 2 μL | 5 μL | 10 μL |
| Removable Needle (RN) Syringe with Dispenser | 201900 | 201910 | 201920 | 201930 | 201940 |



Terasaki Dispenser



PB600-1 Repeating Dispenser

Micro-Pipetting

The PB600-1 Repeating Dispenser consistently dispenses sample between 200 nL–50 μL , up to 50 times with the push of a button. Typical applications include protein crystallization, serology or cell culture.

Micro-Dispensing

| | | | | | | | | |
|--|-------------------|-------------------|------------------|-------------------|--------------------|--------------------|--------------------|--------------------|
| Volume | 10 μL | 25 μL | 50 μL | 100 μL | 250 μL | 500 μL | 1000 μL | 2500 μL |
| Model | 1701 | 1702 | 1705 | 1710 | 1725 | 1750 | 1001 | 1002 |
| Gauge | 26s | 22s | 22s | 22s | 22s | 22 | 22 | 22 |
| Volume Dispensed Per Click | 0.2 μL | 0.5 μL | 1 μL | 2 μL | 5 μL | 10 μL | 20 μL | 50 μL |
| Cemented Needle (N) Syringe (point style 3) | 80075 | 80275 | 80975 | 81075 | 81175 ¹ | 81216 ¹ | 81316 ¹ | 81416 ¹ |

PB600-1 Repeating Dispenser (no syringe included): 83700²

Note: Needles are 51 mm

1) LTN termination

2) All syringes listed in this table are compatible with the PB600-1 dispenser

Product Listing by Features

This section provides feature-based descriptions of Hamilton syringes and needles along with a selection of top items within each category. Product families, series and their components are defined to help you determine the correct item that suits your specific application.

A guide to syringe terminations and needle points can be found on page 4.

Microliter Syringes

Microliter syringes are for use with liquids only. They incorporate a hand-fitted stainless steel plunger with a finely bored syringe barrel. These syringes are ideal for aqueous and organics samples that are not prone to precipitation, crystallization or bonding with glass.



700 Series

The stainless steel plunger is manufactured to fit the glass barrel with a tolerance held within millionths of an inch, resulting in unsurpassed syringe life.



| Volume | 5 µL | 10 µL | 25 µL | 50 µL | 100 µL | 250 µL | 500 µL |
|--|------------|-----------------------------|------------|------------|------------|--------------------|------------|
| Model | 75 | 701 | 702 | 705 | 710 | 725 | 750 |
| Gauge | 26s | 26s | 22s | 22s | 22s | 22s | 22 |
| Cemented Needle (N) Syringe (point style 2) | 87900 | 80300 80366 (6 pk) | 80400 | 80500 | 80600 | 80700 | 80800 |
| Cemented Needle (N) Syringe (point style 3) | 87919 | 80383 80365 ² | 80465 | 80565 | 80665 | 80765 ¹ | 80865 |
| Cemented Needle (N) Syringe (specify needle) | 87908 | 80308 | 80408 | 80508 | 80608 | 80708 | 80808 |
| Removable Needle (RN) Syringe (point style 2) | 87930 | 80330 80336 (6 pk) | 80430 | 80530 | 80630 | 80730 | 80830 |
| Removable Needle (RN) Syringe (needle sold separately) | 7634-01 | 7635-01 | 7636-01 | 7637-01 | 7638-01 | 7639-01 | 7640-01 |
| Luer Tip (LT) Syringe (needle sold separately) | | 80301 | 80401 | 80501 | 80601 | 80701 | 80801 |

Note: Needles are 51 mm unless user specified
1) 22 gauge
2) 22s gauge



800 Series

The 800 series syringes are a reinforced plunger version of the 700 series. A removable blue syringe holder is attached to the flange of the syringe that prevents heat transfer, dispense inaccuracies, plunger blow outs and plunger bending during injection.



| Volume | 5 µL | 10 µL | 25 µL | 50 µL | 100 µL | 250 µL |
|--|------------|------------|------------|------------|------------|------------|
| Model | 85 | 801 | 802 | 805 | 810 | 825 |
| Gauge | 26s | 26s | 22s | 22s | 22s | 22s |
| Removable Needle (RN) Syringe (point style 2) | 84851 | 84853 | 84855 | 84857 | 84859 | 84861 |
| Removable Needle (RN) Syringe (needle sold separately) | 7641-01 | 7642-01 | 7643-01 | 7644-01 | 7645-01 | 7646-01 |

Note: Needles are 51 mm

7000 Series

The 7000 series syringe is used for dispensing minute liquid volumes and features a Modified Microliter design. The end of the plunger has a tungsten wire extension that fits the entire length of the needle all the way to the tip, resulting in a zero dead volume syringe.



| Volume | 0.5 µL | 0.5 µL | 1 µL | 1 µL | 2 µL | 2 µL | 5 µL |
|--|--------------------|---------------|-------------|-------------|-------------|-------------|-------------|
| Model | 7000.5 | 7000.5 | 7001 | 7101 | 7002 | 7102 | 7105 |
| Gauge | 32 | 25 | 25 | 22 | 25 | 23 | 24 |
| Knurled Hub (KH) Syringe (point style 2) | | 86259 | 80135 | 86211 | 88411 | 88511 | 88011 |
| Knurled Hub (KH) Syringe (point style 3) | 86257 ¹ | 86250 | 80100 | 86200 | 88400 | 88500 | 88000 |

Note: Needles are 70 mm
1) Needle length is 100 mm

For a full list of all syringes available, visit www.hamiltoncompany.com/syringes

Gastight Syringes

Gastight syringes are ideal for dispensing both liquids and gases. They have a precision-machined polymer plunger tip, often PTFE, which creates a leak-free seal. With the tight fit, the tip essentially wipes the interior of the syringe barrel free of sample. This feature is useful for samples with dissolved or suspended molecules because it reduces the chance a deposit will occur and result in a damaged plunger.

A guide to syringe terminations and needle points can be found on page 4.

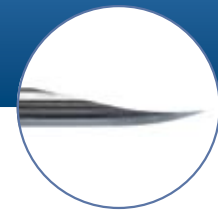

1000 Series

The 1000 series syringe is a mid-volume Gastight syringe.



| Volume | 1 mL | 2.5 mL | 5 mL | 10 mL | 25 mL | 50 mL | 100 mL |
|--|-----------------------------|-------------|-------------|-------------|-------------|-------------|-------------|
| Model | 1001 | 1002 | 1005 | 1010 | 1025 | 1050 | 1100 |
| Gauge | 22 | 22 | 22 | 22 | 22 | 22 | 22 |
| Cemented Needle (LTN) Syringe (point style 2) | 81317 | 81417 | 81517 | 81617 | | | |
| Cemented Needle (LTN) Syringe (point style 3) | 81316 | 81416 | 81516 | 81616 | | | |
| Cemented Needle (LTN) Syringe (specify needle) | 81314 | 81414 | 81514 | 81614 | | | |
| Removable Needle (RN) Syringe (point style 2) | 81330 81365 ¹ | 81430 | 81530 | 81630 | | | |
| Removable Needle (RN) Syringe (needle sold separately) | 7649-01 | 7650-01 | 7651-01 | 7652-01 | | | |
| Luer Tip (LT) Syringe (needle sold separately) | 81301 | 81401 | 81501 | 81601 | | | |
| SampleLock (SL) Syringe (point style 2) | 81356 | 81456 | 81556 | 81656 | 86326 | 86336 | 86346 |
| PTFE Luer Lock (TLL) Syringe (needle sold separately) | 81320 | 81420 | 81520 | 81620 | 82520 | 85020 | 86020 |
| ChemSeal (C) Syringe (no needle available) | 81360 | 81460 | 81560 | 81660 | | | |

Note: Needles are 51 mm unless user specified
 1) Needle is point style 3



1700 Series

The 1700 series syringe is the Gastight version of the 700 series syringes.



| Volume | 10 µL | 25 µL | 50 µL | 100 µL | 250 µL | 500 µL |
|--|--------------------|-------------|-------------|-------------|--------------------|--------------------|
| Model | 1701 | 1702 | 1705 | 1710 | 1725 | 1750 |
| Gauge | 26s | 22s | 22s | 22s | 22s | 22 |
| Cemented Needle (N) Syringe (point style 2) | 80000 | 80200 | 80900 | 81000 | 81100 ¹ | 81217 ¹ |
| Cemented Needle (N) Syringe (point style 3) | 80075 | 80275 | 80975 | 81075 | 81175 ¹ | 81216 ¹ |
| Cemented Needle (N) Syringe (specify needle) | 80008 | 80208 | 80908 | 81008 | 81108 ¹ | 81214 ¹ |
| Removable Needle (RN) Syringe (point style 2) | 80030 | 80230 | 80930 | 81030 | 81130 | 81230 |
| Removable Needle (RN) Syringe (point style 3) | 80065 ² | 80265 | 80965 | 81065 | 81165 ³ | 81265 |
| Removable Needle (RN) Syringe (needle sold separately) | 7653-01 | 7654-01 | 7655-01 | 7656-01 | 7657-01 | 7658-01 |
| Luer Tip (LT) Syringe (needle sold separately) | 80001 | 80201 | 80901 | 81001 | 81101 | 81201 |
| SampleLock (SL) Syringe (point style 2) | | | 80956 | 81056 | 81156 | 81256 |
| PTFE Luer Lock (TLL) Syringe (needle sold separately) | | | 80920 | 81020 | 81120 | 81220 |
| ChemSeal (C) (no needle available) | 80062 | 80262 | 80962 | 81062 | 81162 | 81262 |

Note: Needles are 51 mm unless user specified
 1) LTN termination
 2) 22s gauge
 3) 22 gauge

1800 Series

The 1800 series syringe is the Gastight version of the 800 series syringes.







| Volume | 10 µL | 25 µL | 50 µL | 100 µL | 250 µL |
|--|-------------|-------------|-------------|-------------|-------------|
| Model | 1801 | 1802 | 1805 | 1810 | 1825 |
| Gauge | 26s | 22s | 22s | 22s | 22s |
| Removable Needle (RN) Syringe (point style 2) | 84877 | 84880 | 84883 | 84886 | 84889 |
| Removable Needle (RN) Syringe (needle sold separately) | 7659-01 | 7660-01 | 7661-01 | 7662-01 | 7663-01 |

Note: Needles are 51 mm unless user specified

Needles

Hamilton Company offers the widest variety of standard and custom needles in the industry. With needle gauges from 10 to 34 and lengths from 9.53 mm (0.375 inches) to more than 304.79 mm (12 inches), almost any needle is possible. Standard needle length is 51 mm (2 inches). All needles are manufactured from 304 stainless steel.

Needle Types

| Needle Type | | Available Gauges | Remarks |
|---------------------------------|---|------------------|--|
| Small Hub Removable Needle (RN) |  | 27-34 | Small hub removable (RN) needles can be used with removable (RN)-style syringes that are 100 µL and smaller. |
| |  | 18-26s | |
| Large Hub Removable Needle (RN) |  | 20-26s | Large hub removable (RN) needles can be used with removable (RN)-style syringes that are 250 µL and larger. |
| Kel-F Hub Needle (KF) |  | 10-31 | Kel-F hub (KF) needles can be used with Luer Tip (LT) and PTFE Luer Lock (TLL) syringes and connectors. |
| Metal Hub Needle (N) |  | 10-33 | Metal hub (N) (Nickel plated brass) needles can be used with TLL syringes and LT or TLL connectors. |

The Hamilton NeedleBuilder™ is Here!

For the first time ever, you can control the needle building process from start to finish, ensuring you get exactly what you need.



Visit www.hamiltoncompany.com/nb to build your custom needle!



Standard Needles

| Gauge | O.D. X I.D. (mm) | Point Style | Small RN | Large RN | Metal Hub | Kel-F Hub |
|-------|------------------|-------------|----------------------|----------|-----------|-----------|
| 33 | 0.21 x 0.11 | 3 | 7762-06 ¹ | | | |
| 32 | 0.24 x 0.11 | 3 | 7762-05 | | | |
| 31 | 0.26 x 0.13 | 3 | 7762-04 | | | |
| 30 | 0.31 x 0.16 | 3 | 7762-03 | | | |
| 28 | 0.36 x 0.18 | 3 | 7762-02 | | | |
| 27 | 0.41 x 0.21 | 3 | 7762-01 | | | |
| 26s | 0.47 x 0.13 | 2 | 7758-02 | 7779-02 | 90039 | 90139 |
| | | 3 | 7768-01 | 7780-01 | 91039 | 90539 |
| | | 5 | 7784-07 | 7784-03 | 7729-01 | 7746-12 |
| 26 | 0.46 x 0.26 | 2 | 7758-04 | 7779-04 | 90026 | 90126 |
| | | 3 | 7768-02 | 7780-02 | 91026 | 90533 |
| | | 5 | 7784-08 | 7784-04 | 7729-03 | 7746-10 |
| 25 | 0.52 x 0.26 | 2 | | | 90025 | 90125 |
| | | 3 | | | 91025 | 90525 |
| | | 5 | | | 7729-04 | 7746-09 |
| 24 | 0.57 x 0.31 | 2 | | | 90024 | 90124 |
| | | 3 | | | 91024 | 90524 |
| | | 5 | | | 7729-05 | 7746-08 |
| 23 | 0.64 x 0.34 | 2 | | | 90023 | 90123 |
| | | 3 | | | 91023 | 90523 |
| | | 5 | | | 7729-06 | 7746-07 |
| 22s | 0.72 x 0.17 | 2 | 7758-03 | 7779-03 | 90038 | 90138 |
| | | 3 | 7770-01 | 7780-03 | 91038 | 90534 |
| | | 5 | 7748-05 | 7784-01 | 7729-02 | 7746-11 |
| 22 | 0.72 x 0.41 | 2 | 7758-01 | 7779-01 | 90022 | 90122 |
| | | 3 | 7770-02 | 7780-04 | 91022 | 90134 |
| | | 5 | 7784-06 | 7784-02 | 7729-07 | 7746-06 |
| 21 | 0.82 x 0.51 | 2 | | | 90021 | 90121 |
| | | 3 | | | 91021 | 90521 |
| | | 5 | | | 7729-08 | 7746-05 |
| 20 | 0.91 x 0.60 | 2 | | | 90020 | 90120 |
| | | 3 | | | 91020 | 90520 |
| | | 5 | | | 7729-09 | 7746-04 |

Note: All needles come in a six pack and are 51 mm in length
 1) Length is 38.1 mm

Custom Needles

| Gauge | O.D. X I.D. (mm) | Point Style | Small RN | Large RN | Metal Hub | Kel-F Hub |
|-------|------------------|-------------|----------|----------|-----------|-----------|
| 34 | 0.16 x 0.05 | 2, 3 or 4 | 207434 | | | |
| 33 | 0.21 x 0.11 | 2, 3 or 4 | 7803-05 | | 7747-01 | |
| 32 | 0.24 x 0.11 | 2, 3 or 4 | 7803-04 | | 7747-02 | |
| 31 | 0.26 x 0.13 | 2, 3 or 4 | 7803-03 | | 7748-17 | 7750-22 |
| 30 | 0.31 x 0.16 | 2, 3 or 4 | 7803-07 | | 7748-16 | 7750-21 |
| 29 | 0.34 x 0.18 | 2, 3 or 4 | 7803-06 | | 7748-15 | 7750-20 |
| 28 | 0.36 x 0.18 | 2, 3 or 4 | 7803-02 | | 7748-14 | 7750-19 |
| 27 | 0.41 x 0.21 | 2, 3 or 4 | 7803-01 | | 7748-13 | 7750-18 |
| 26s | 0.47 x 0.13 | 2, 3 or 4 | 7804-04 | 7806-04 | 7748-19 | 7750-24 |
| | | 5 or AS | 7731-02 | 7732-04 | 7751-19 | 7752-19 |
| 26 | 0.46 x 0.26 | 2, 3 or 4 | 7804-03 | 7806-03 | 7748-12 | 7750-17 |
| | | 5 or AS | 7731-01 | 7732-03 | 7751-17 | 7752-17 |
| 25s | 0.52 x 0.15 | 2, 3 or 4 | 7804-10 | 7806-09 | 7748-21 | 7750-26 |
| | | 5 or AS | 7731-06 | 7732-09 | 7751-21 | 7752-21 |
| 25 | 0.52 x 0.26 | 2, 3 or 4 | 7804-05 | 7806-07 | 7748-11 | 7750-16 |
| | | 5 or AS | 7731-05 | 7732-05 | 7751-16 | 7752-16 |
| 24 | 0.57 x 0.31 | 2, 3 or 4 | 7804-08 | 7806-06 | 7748-10 | 7750-15 |
| | | 5 or AS | 7731-09 | 7732-07 | 7751-15 | 7752-15 |
| 23s | 0.64 x 0.12 | 2, 3 or 4 | 7804-09 | 7806-08 | 7748-20 | 7750-25 |
| | | 5 or AS | 7731-08 | 7732-08 | 7751-20 | 7752-20 |
| 23 | 0.64 x 0.34 | 2, 3 or 4 | 7804-07 | 7806-05 | 7748-09 | 7750-14 |
| | | 5 or AS | 7731-07 | 7732-06 | 7751-14 | 7752-14 |
| 22s | 0.72 x 0.17 | 2, 3 or 4 | 7804-02 | 7806-02 | 7748-18 | 7750-23 |
| | | 5 or AS | 7731-04 | 7732-02 | 7751-18 | 7752-18 |
| 22 | 0.72 x 0.41 | 2, 3 or 4 | 7804-01 | 7806-01 | 7748-08 | 7750-13 |
| | | 5 or AS | 7731-03 | 7732-01 | 7751-13 | 7752-13 |
| 21 | 0.82 x 0.51 | 2, 3 or 4 | 7804-12 | 7806-11 | 7748-07 | 7750-12 |
| | | 5 or AS | 7731-11 | 7732-11 | 7751-12 | 7752-12 |
| 20 | 0.91 x 0.60 | 2, 3 or 4 | 7804-11 | 7806-10 | 7748-06 | 7750-11 |
| | | 5 or AS | 7731-10 | 7732-10 | 7751-11 | 7752-11 |

Note: All needles come in a six pack. Please specify needle length and point style.

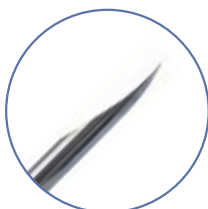

Point style 2

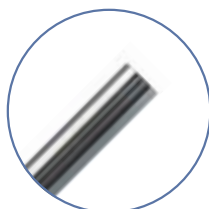

Point style 3

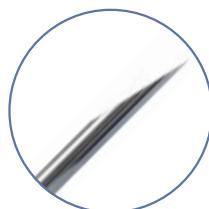

Point style 4



Point style 5

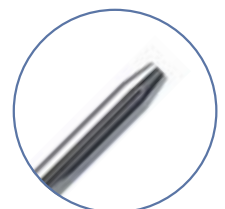

Point style AS



Custom Needles continued

| Gauge | O.D. X I.D. (mm) | Point Style | Small RN | Metal Hub | Kel-F Hub |
|-------|------------------|-------------|----------|-----------|-----------|
| 19 | 1.07 x 0.69 | 2, 3 or 4 | 207419 | 7748-05 | 7750-10 |
| | | 5 or AS | | 7751-10 | 7752-10 |
| 18 | 1.27 x 0.84 | 2, 3 or 4 | 7804-06 | 7748-04 | 7750-09 |
| | | 5 or AS | | 7751-09 | 7752-09 |
| 17 | 1.47 x 1.07 | 2, 3 or 4 | | 7748-03 | 7750-08 |
| | | 5 or AS | | 7751-08 | 7752-08 |
| 16 | 1.65 x 1.19 | 2, 3 or 4 | | 7748-02 | 7750-07 |
| | | 5 or AS | | 7751-07 | 7752-07 |
| 15 | 1.83 x 1.37 | 2, 3 or 4 | | 7748-01 | 7750-06 |
| | | 5 or AS | | 7751-06 | 7752-06 |
| 14 | 2.11 x 1.60 | 2, 3 or 4 | | 7749-05 | 7750-05 |
| | | 5 or AS | | 7751-05 | 7752-05 |
| 13 | 2.41 x 1.80 | 2, 3 or 4 | | 7749-04 | 7750-04 |
| | | 5 or AS | | 7751-04 | 7752-04 |
| 12 | 2.77 x 2.16 | 2, 3 or 4 | | 7749-03 | 7750-03 |
| | | 5 or AS | | 7751-03 | 7752-03 |
| 11 | 3.05 x 2.39 | 2, 3 or 4 | | 7749-02 | 7750-02 |
| | | 5 or AS | | 7751-02 | 7752-02 |
| 10 | 3.40 x 2.70 | 2, 3 or 4 | | 7749-01 | 7750-01 |
| | | 5 or AS | | 7751-01 | 7752-01 |

Note: All needles come in a six pack. Please specify needle length and point style.

Custom needles usually ship within 5-7 business days.



Syringe Care and Use

The life of your Hamilton syringe is directly related to its cleanliness and proper care. In general, solvents suitable for routine cleaning include methanol, acetonitrile and acetone. Use solvents of high purity grade. Halogenated hydrocarbons should not be used because they may damage some glue joints.

Chemical Compatibility

The adhesive used to affix needles and hubs to Hamilton Gastight and Microliter syringes is the most chemically resistant available. However, with prolonged exposure, some solvents may attack and deteriorate this highly resistant adhesive. In particular, caution should be exercised with solvents containing halogenated hydrocarbons such as dichloromethane (methylene chloride). For applications using these solvents, Removable Needle (RN) syringes are recommended because no adhesive is present in the fluid path. Be sure to rinse the syringe thoroughly after each use with a solvent that is known to solubilize your sample followed by a solvent such as acetone to ensure that the glue does not remain in contact with a potentially harmful solvent.

Cleaning Syringes

Rinse the syringe after use with an appropriate solvent (i.e., a solvent known to be effective in solvating the sample). Preferred cleaning agents are non-alkaline, non-phosphate and non-detergent based. A biodegradable, non-phosphate, organic Cleaning Solution Concentrate is available from Hamilton (p/n 18311). Following the use of a cleaning agent, rinse the syringe with deionized water and finally acetone. Wipe the exterior surfaces of the syringe barrel and needle dry with a lint-free tissue. Make sure that there is no residual cleaning agent in the syringe before using or storing the syringe. Do not soak or submerge the entire syringe in any cleaning agent. Prolonged contact with cleaning agents may damage bonded parts. It is recommended that the syringe be placed into the original packaging after it is properly cleaned.



Needle Cleaning Kit



Clogged Needles

Do not attempt to clean clogged needles by forcing liquid or compressed air through the syringe. Excessive pressure will split the glass barrel. Instead, use the Hamilton Needle Cleaning Kit (p/n 76620). Start by using the cleaning wires to dislodge any foreign material. Then flush with the Cleaning Solution Concentrate to further dissolve the clog. Once the clog is removed, rinse the syringe and needle thoroughly with deionized water. Wipe the exterior surfaces of the syringe barrel and needle dry with a lint-free tissue. Make sure that there is no residual cleaning agent in the syringe before using or storing the syringe.

Storage

After Hamilton syringes are cleaned and dried store them in the original packaging or on the syringe rack (p/n 204880) to prevent breakage or damage.

Sterilizing Syringes

Chemical sterilizers are the best means for sterilizing syringes. Hamilton syringes may be sterilized with ethylene oxide. LT, TLL and disassembled RN syringes may be autoclaved at a temperature of up to 115 °C. However, repeated autoclaving will shorten syringe life. When autoclaving is required, remove the plunger from the syringe. Autoclaving cemented needle syringes is not recommended as glass and metal expands at different rates which would compromise the glued connection. If your application only requires disinfection, then Hamilton recommends the use of Microside SQ®.

Lubricating Syringes

A clean syringe does not require any lubricating grease. Grease may lead to a variety of problems including sample contamination, seizing of the plunger and barrel damage.



Syringe Rack



Syringe Troubleshooting

| Problem | Possible Cause | Suggested Solution |
|---------------------------|--|---|
| Clogged needle | Worn GC septa | Replace GC septa |
| | Poor syringe cleaning | Ensure proper needle cleaning with Hamilton cleaning wires and cleaning concentrate |
| | Viscous sample | Select a larger needle gauge for viscous sample |
| Bent plunger | Inappropriate handling technique | Use syringe with reinforced plunger |
| | Poor storage | Store syringes on the syringe rack or in their original packaging |
| Seized Microliter plunger | Deposits between the glass barrel and the plunger wire | Avoid operating the syringe dry Ensure proper syringe cleaning, it may be possible to free the plunger using a solvent known to solubilize your sample |
| Low reproducibility | Inappropriate handling technique | Use Reproducibility (Chaney) Adapter |
| Air bubbles | Insufficient priming | Fully prime the syringe by inserting the needle into the sample and slowly aspirating and dispensing |
| Needle leakage | Inappropriate sealing of the needle | Remount needle checking that the cleaning wire has been removed and there is no damage to the plastic seal |
| Cemented needle is loose | Solvents have attacked the glue holding the needle | Use RN syringes that have no glue in the fluid path, especially with halogenated solvents |
| Gastight plunger leakage | Plunger tip damaged due to age | Replace plunger |
| | Plunger tip damage due to deposits on the glass | Improve cleaning to eliminate deposits. For some applications SaltLine syringes may provide longer life. |
| Carryover | Inappropriate syringe cleaning | Ensure proper syringe and needle cleaning |
| | Inappropriate syringe selection | Use a Gastight syringe with aqueous samples |



Part Number Index

| | | | | | | | |
|--------------|----------------|--------------|--------|--------------|----------|---------------|------------|
| PRMKIT..... | 31, 33 | 7746-12..... | 41 | 7751-14..... | 42 | 7804-02..... | 42 |
| 7634-01..... | 29, 31, 33, 36 | 7747-01..... | 42 | 7751-15..... | 42 | 7804-03..... | 42 |
| 7635-01..... | 36 | 7747-02..... | 42 | 7751-16..... | 42 | 7804-04..... | 42 |
| 7636-01..... | 36 | 7748-01..... | 43 | 7751-17..... | 42 | 7804-05..... | 42 |
| 7637-01..... | 36 | 7748-02..... | 43 | 7751-18..... | 42 | 7804-06..... | 43 |
| 7638-01..... | 36 | 7748-03..... | 43 | 7751-19..... | 42 | 7804-07..... | 42 |
| 7639-01..... | 36 | 7748-04..... | 43 | 7751-20..... | 42 | 7804-08..... | 42 |
| 7640-01..... | 36 | 7748-05..... | 41, 43 | 7751-21..... | 42 | 7804-09..... | 42 |
| 7641-01..... | 37 | 7748-06..... | 42 | 7752-01..... | 43 | 7804-10..... | 42 |
| 7642-01..... | 37 | 7748-07..... | 42 | 7752-02..... | 43 | 7804-11..... | 42 |
| 7643-01..... | 37 | 7748-08..... | 42 | 7752-03..... | 43 | 7804-12..... | 42 |
| 7644-01..... | 37 | 7748-09..... | 42 | 7752-04..... | 43 | 7806-01..... | 42 |
| 7645-01..... | 37 | 7748-10..... | 42 | 7752-05..... | 43 | 7806-02..... | 18, 42 |
| 7646-01..... | 37 | 7748-11..... | 42 | 7752-06..... | 43 | 7806-03..... | 42 |
| 7649-01..... | 38 | 7748-12..... | 42 | 7752-07..... | 43 | 7806-04..... | 42 |
| 7650-01..... | 38 | 7748-13..... | 42 | 7752-08..... | 43 | 7806-05..... | 42 |
| 7651-01..... | 38 | 7748-14..... | 42 | 7752-09..... | 43 | 7806-06..... | 42 |
| 7652-01..... | 38 | 7748-15..... | 42 | 7752-10..... | 43 | 7806-07..... | 42 |
| 7653-01..... | 29, 31, 33, 39 | 7748-16..... | 42 | 7752-11..... | 42 | 7806-08..... | 42 |
| 7654-01..... | 29, 31, 33, 39 | 7748-17..... | 42 | 7752-12..... | 42 | 7806-09..... | 42 |
| 7655-01..... | 29, 31, 33, 39 | 7748-18..... | 42 | 7752-13..... | 42 | 7806-10..... | 42 |
| 7656-01..... | 29, 31, 33, 39 | 7748-19..... | 42 | 7752-14..... | 42 | 7806-11..... | 42 |
| 7657-01..... | 39 | 7748-20..... | 42 | 7752-15..... | 42 | 14700..... | 9, 18 |
| 7658-01..... | 39 | 7748-21..... | 42 | 7752-16..... | 42 | 14725..... | 9, 18 |
| 7659-01..... | 39 | 7749-01..... | 43 | 7752-17..... | 42 | 18311..... | 44 |
| 7660-01..... | 39 | 7749-02..... | 43 | 7752-18..... | 42 | 20912..... | 27 |
| 7661-01..... | 39 | 7749-03..... | 43 | 7752-19..... | 42 | 20918..... | 27 |
| 7662-01..... | 39 | 7749-04..... | 43 | 7752-20..... | 42 | 20922..... | 27 |
| 7663-01..... | 39 | 7749-05..... | 43 | 7752-21..... | 42 | 20930..... | 27 |
| 7729-01..... | 41 | 7750-01..... | 43 | 7758-01..... | 41 | 54658-01..... | 23, 24, 25 |
| 7729-02..... | 41 | 7750-02..... | 43 | 7758-02..... | 7, 8, 41 | 54659-01..... | 23, 24, 25 |
| 7729-03..... | 41 | 7750-03..... | 43 | 7758-03..... | 7, 8, 41 | 54660-01..... | 23, 24, 25 |
| 7729-04..... | 41 | 7750-04..... | 43 | 7758-04..... | 41 | 54661-01..... | 23, 24, 25 |
| 7729-05..... | 41 | 7750-05..... | 43 | 7762-01..... | 41 | 54662-01..... | 23, 24, 25 |
| 7729-06..... | 41 | 7750-06..... | 43 | 7762-02..... | 41 | 55750-01..... | 31, 33 |
| 7729-07..... | 41 | 7750-07..... | 43 | 7762-03..... | 41 | 55751-01..... | 33 |
| 7729-08..... | 41 | 7750-08..... | 43 | 7762-04..... | 41 | 55752-01..... | 33 |
| 7729-09..... | 41 | 7750-09..... | 43 | 7762-05..... | 41 | 59000-05..... | 27 |
| 7731-01..... | 42 | 7750-10..... | 43 | 7762-06..... | 41 | 59000-10..... | 27 |
| 7731-02..... | 42 | 7750-11..... | 42 | 7768-01..... | 41 | 59000-15..... | 27 |
| 7731-03..... | 42 | 7750-12..... | 42 | 7768-02..... | 41 | 59000-20..... | 27 |
| 7731-04..... | 42 | 7750-13..... | 42 | 7770-01..... | 17, 41 | 59000-25..... | 27 |
| 7731-05..... | 42 | 7750-14..... | 42 | 7770-02..... | 41 | 59000-30..... | 27 |
| 7731-06..... | 42 | 7750-15..... | 42 | 7779-01..... | 7, 8, 41 | 59000-35..... | 27 |
| 7731-07..... | 42 | 7750-16..... | 42 | 7779-02..... | 41 | 59000-40..... | 27 |
| 7731-08..... | 42 | 7750-17..... | 42 | 7779-03..... | 7, 8, 41 | 59000-45..... | 27 |
| 7731-09..... | 42 | 7750-18..... | 42 | 7779-04..... | 41 | 59000-50..... | 27 |
| 7731-10..... | 42 | 7750-19..... | 42 | 7780-01..... | 41 | 59000-55..... | 27 |
| 7731-11..... | 42 | 7750-20..... | 42 | 7780-02..... | 41 | 59000-60..... | 27 |
| 7732-01..... | 42 | 7750-21..... | 42 | 7780-03..... | 17, 41 | 62161-01..... | 23, 24, 25 |
| 7732-02..... | 42 | 7750-22..... | 42 | 7780-04..... | 17, 41 | 65457-01..... | 30 |
| 7732-03..... | 42 | 7750-23..... | 42 | 7784-01..... | 41 | 65458-01..... | 30 |
| 7732-04..... | 42 | 7750-24..... | 42 | 7784-02..... | 41 | 65459-01..... | 30 |
| 7732-05..... | 42 | 7750-25..... | 42 | 7784-03..... | 41 | 65460-02..... | 30 |
| 7732-06..... | 42 | 7750-26..... | 42 | 7784-04..... | 41 | 65460-05..... | 30 |
| 7732-07..... | 42 | 7751-01..... | 43 | 7784-06..... | 41 | 65460-10..... | 30 |
| 7732-08..... | 42 | 7751-02..... | 43 | 7784-07..... | 41 | 65460-15..... | 30 |
| 7732-09..... | 42 | 7751-03..... | 43 | 7784-08..... | 41 | 65460-20..... | 30 |
| 7732-10..... | 42 | 7751-04..... | 43 | 7787-01..... | 18 | 76620..... | 45 |
| 7732-11..... | 42 | 7751-05..... | 43 | 7787-02..... | 18 | 78633..... | 34 |
| 7746-04..... | 41 | 7751-06..... | 43 | 7803-01..... | 29, 42 | 80000..... | 8, 39 |
| 7746-05..... | 41 | 7751-07..... | 43 | 7803-02..... | 29, 42 | 80001..... | 39 |
| 7746-06..... | 41 | 7751-08..... | 43 | 7803-03..... | 29, 42 | 80008..... | 39 |
| 7746-07..... | 41 | 7751-09..... | 43 | 7803-04..... | 29, 42 | 80021..... | 34 |
| 7746-08..... | 41 | 7751-10..... | 43 | 7803-05..... | 29, 42 | 80022..... | 34 |
| 7746-09..... | 41 | 7751-11..... | 42 | 7803-06..... | 29, 42 | 80023..... | 34 |
| 7746-10..... | 41 | 7751-12..... | 42 | 7803-07..... | 29, 42 | 80030..... | 8, 39 |
| 7746-11..... | 41 | 7751-13..... | 42 | 7804-01..... | 42 | 80050..... | 19 |
| | | | | | | 80062..... | 39 |
| | | | | | | 80065..... | 17, 39 |
| | | | | | | 80075..... | 35, 39 |

| | | | | | | | |
|------------|------------|------------|------------|------------|-----------|-------------|------------|
| 80079..... | 13 | 81008..... | 39 | 84851..... | 37 | 90622..... | 27 |
| 80080..... | 13 | 81020..... | 27, 39 | 84853..... | 37 | 90630..... | 27 |
| 80081..... | 34 | 81030..... | 8, 39 | 84855..... | 37 | 90662..... | 27 |
| 80094..... | 13 | 81031..... | 18 | 84857..... | 37 | 90668..... | 27 |
| 80096..... | 13 | 81050..... | 19 | 84859..... | 37 | 90672..... | 27 |
| 80100..... | 37 | 81056..... | 39 | 84861..... | 37 | 90680..... | 27 |
| 80135..... | 7, 37 | 81062..... | 39 | 84877..... | 8, 39 | 91020..... | 41 |
| 80176..... | 13 | 81065..... | 17, 39 | 84880..... | 8, 39 | 91021..... | 41 |
| 80200..... | 8, 39 | 81075..... | 17, 35, 39 | 84883..... | 8, 39 | 91022..... | 41 |
| 80201..... | 39 | 81100..... | 8, 39 | 84886..... | 8, 39 | 91023..... | 41 |
| 80208..... | 39 | 81101..... | 39 | 84889..... | 8, 39 | 91024..... | 41 |
| 80230..... | 8, 39 | 81108..... | 39 | 85020..... | 27, 38 | 91025..... | 41 |
| 80231..... | 18 | 81120..... | 27, 39 | 86020..... | 27, 38 | 91026..... | 41 |
| 80250..... | 19 | 81130..... | 8, 39 | 86200..... | 37 | 91038..... | 41 |
| 80262..... | 39 | 81131..... | 18 | 86201..... | 7 | 91039..... | 41 |
| 80265..... | 17, 39 | 81156..... | 39 | 86211..... | 37 | 201900..... | 35 |
| 80275..... | 17, 35, 39 | 81162..... | 25, 39 | 86250..... | 37 | 201910..... | 35 |
| 80300..... | 7, 14, 36 | 81165..... | 17, 39 | 86257..... | 37 | 201920..... | 35 |
| 80301..... | 36 | 81175..... | 17, 35, 39 | 86259..... | 7, 37 | 201930..... | 35 |
| 80308..... | 10, 36 | 81201..... | 39 | 86274..... | 13 | 201940..... | 35 |
| 80318..... | 14 | 81214..... | 39 | 86276..... | 13 | 202145..... | 23 |
| 80330..... | 7, 15, 36 | 81216..... | 17, 35, 39 | 86326..... | 38 | 202192..... | 23 |
| 80336..... | 7, 36 | 81217..... | 8, 39 | 86336..... | 38 | 202630..... | 15 |
| 80365..... | 17, 36 | 81220..... | 27, 39 | 86346..... | 38 | 202640..... | 15 |
| 80366..... | 7, 14, 36 | 81230..... | 8, 39 | 87402..... | 10 | 202660..... | 14 |
| 80383..... | 36 | 81231..... | 18 | 87900..... | 7, 14, 36 | 202880..... | 14 |
| 80387..... | 13 | 81256..... | 39 | 87908..... | 36 | 203043..... | 12 |
| 80388..... | 13 | 81262..... | 25, 39 | 87919..... | 36 | 203075..... | 21, 23, 24 |
| 80389..... | 13 | 81265..... | 17, 39 | 87930..... | 7, 15, 36 | 203076..... | 12 |
| 80390..... | 13 | 81301..... | 38 | 87987..... | 13 | 203077..... | 21, 23, 24 |
| 80391..... | 13 | 81314..... | 38 | 87988..... | 13 | 203078..... | 12 |
| 80393..... | 13 | 81316..... | 17, 35, 38 | 87989..... | 13 | 203079..... | 21, 23, 24 |
| 80400..... | 7, 36 | 81317..... | 8, 38 | 87990..... | 13 | 203080..... | 12 |
| 80401..... | 36 | 81320..... | 27, 38 | 87993..... | 13 | 203081..... | 21, 23, 24 |
| 80408..... | 36 | 81330..... | 8, 38 | 87994..... | 13 | 203082..... | 12 |
| 80430..... | 7, 36 | 81331..... | 18 | 88000..... | 37 | 203083..... | 21, 23, 24 |
| 80465..... | 17, 36 | 81356..... | 38 | 88011..... | 7, 37 | 203084..... | 12 |
| 80500..... | 7, 36 | 81360..... | 23, 25, 38 | 88400..... | 37 | 203085..... | 21, 23, 24 |
| 80501..... | 36 | 81365..... | 17, 38 | 88411..... | 7, 37 | 203086..... | 12 |
| 80508..... | 36 | 81401..... | 38 | 88500..... | 37 | 203141..... | 12 |
| 80530..... | 7, 36 | 81414..... | 38 | 88511..... | 37 | 203181..... | 12 |
| 80565..... | 17, 36 | 81416..... | 35, 38 | 90020..... | 41 | 203182..... | 12 |
| 80600..... | 7, 36 | 81417..... | 8, 38 | 90021..... | 41 | 203185..... | 12 |
| 80601..... | 36 | 81420..... | 27, 38 | 90022..... | 41 | 203189..... | 12 |
| 80608..... | 36 | 81430..... | 8, 38 | 90023..... | 41 | 203194..... | 21, 23, 24 |
| 80630..... | 7, 36 | 81456..... | 38 | 90024..... | 41 | 203205..... | 12 |
| 80665..... | 17, 36 | 81460..... | 23, 25, 38 | 90025..... | 41 | 203220..... | 27 |
| 80700..... | 7, 36 | 81501..... | 38 | 90026..... | 41 | 203230..... | 27 |
| 80701..... | 36 | 81514..... | 38 | 90038..... | 41 | 203240..... | 27 |
| 80708..... | 36 | 81516..... | 38 | 90039..... | 41 | 203250..... | 27 |
| 80730..... | 7, 36 | 81517..... | 8, 38 | 90120..... | 41 | 203260..... | 27 |
| 80765..... | 17, 36 | 81520..... | 27, 38 | 90121..... | 41 | 203270..... | 27 |
| 80800..... | 7, 36 | 81530..... | 8, 38 | 90122..... | 41 | 203349..... | 21, 23, 24 |
| 80801..... | 36 | 81556..... | 38 | 90123..... | 41 | 203361..... | 12 |
| 80808..... | 36 | 81560..... | 23, 38 | 90124..... | 41 | 204000..... | 14 |
| 80830..... | 7, 36 | 81601..... | 38 | 90125..... | 41 | 204001..... | 14 |
| 80865..... | 17, 36 | 81614..... | 38 | 90126..... | 41 | 204051..... | 14 |
| 80900..... | 8, 39 | 81616..... | 38 | 90134..... | 41 | 204052..... | 14 |
| 80901..... | 39 | 81617..... | 8, 38 | 90138..... | 41 | 204400..... | 21 |
| 80908..... | 39 | 81620..... | 27, 38 | 90139..... | 41 | 204452..... | 21 |
| 80920..... | 27, 39 | 81630..... | 8, 38 | 90520..... | 41 | 204475..... | 21 |
| 80930..... | 8, 39 | 81656..... | 38 | 90521..... | 41 | 204880..... | 45 |
| 80931..... | 18 | 81660..... | 38 | 90523..... | 41 | 207419..... | 43 |
| 80950..... | 19 | 82520..... | 27, 38 | 90524..... | 41 | 207434..... | 29, 42 |
| 80956..... | 39 | 84502..... | 34 | 90525..... | 41 | 208335..... | 27 |
| 80962..... | 25, 39 | 84503..... | 34 | 90533..... | 41 | 208336..... | 27 |
| 80965..... | 17, 39 | 84504..... | 34 | 90534..... | 41 | 208337..... | 27 |
| 80975..... | 17, 35, 39 | 84505..... | 34 | 90539..... | 41 | | |
| 81000..... | 8, 39 | 84511..... | 34 | 90612..... | 27 | | |
| 81001..... | 39 | 84611..... | 34 | 90618..... | 27 | | |



About Hamilton Company

Hamilton Company is a global enterprise with headquarters in Reno, Nevada, Hopkinton, Massachusetts, and Bonaduz, Switzerland and subsidiary offices throughout the world.

We are an industry leader in the design and manufacture of liquid handling, process analytics, robotics and automated storage solutions. For more than 50 years, Hamilton has been satisfying customer needs by combining quality materials with skilled workmanship to ensure the highest level of performance. Hamilton's lifelong commitment to precision and quality has earned us global ISO 9001 Certification.



Founded on the technology of analytical Microliter™ and Gastight® syringes, Hamilton has a broad offering of laboratory products including manual and semi-automated precision fluid measuring instruments, chromatography products, process sensors, laboratory electrodes, pipettes and more. Top innovations from these lines include Arc™ pH, DO and conductivity intelligent sensors, the BioLevigator™ and Microlab® 600 diluters/dispensers.

A pioneer in liquid handling equipment and laboratory automation technology, Hamilton Robotics is known for advancing life science and biotechnology industries through reliability, performance and flexibility. Hamilton continues to be the market leader with patented technologies such as Compression-induced O-Ring Expansion (CO-RE), Total Aspiration and Dispensing Monitoring (TADM) and Anti Droplet Control (ADC). Hamilton's feature platform, Microlab STAR, is the highest selling automated pipetting platform for several years running, while Microlab NIMBUS® is the first in class of compact, high-speed personalized pipetting workstations.



The Hamilton Storage Technologies division offers comprehensive ultra-low temperature automated sample management systems for a broad array of life science processes. Its line of biobanking, compound storage and consumable solutions consists of products such as BIOS™, SAM™ and ASM™, designed for sample integrity, flexibility, and reliability.

Hamilton Company is focused on blending invention and accuracy to deliver customers unparalleled products.



Your Hamilton Representative

© 2012 Hamilton Company. All rights reserved.
Thermo Scientific is a registered trademark of Thermo Fisher Scientific Inc.
Valco® is a registered trademark of Valco Instruments Co. Inc.
Rheodyne is a registered trademark of Units of IDEX® Corporation.
Waters is a registered trademark of Waters.
PerkinElmer and Flexar are registered trademarks of PerkinElmer, Inc.
Merlin MicroSeal is a trademark of Merlin Instrument Company.
Microside SQ is a registered trademark of Global Biotechnologies, Inc. in the U.S. and/or other countries.
PAL is a registered trademark of CTC Analytics AG, Switzerland.

All other trademarks are owned and/or registered by Hamilton Company in the U.S. and/or other countries.
Lit. No. L20078 Rev. A — 10/2012

HAMILTON®

Web: www.hamiltoncompany.com

USA: 800-648-5950

Europe: +41-81-660-60-60

Hamilton Americas & Pacific Rim

4970 Energy Way
Reno, Nevada 89502 USA
Tel: +1-775-858-3000
Fax: +1-775-856-7259
sales@hamiltoncompany.com

Hamilton Europe, Asia, & Africa

Via Crusch 8
CH-7402 Bonaduz, GR, Switzerland
Tel: +41-81-660-60-60
Fax: +41-81-660-60-70
contact@hamilton.ch

To find a representative in your area, please visit hamiltoncompany.com/contacts.